



## MIS232T3EPH466

Int.StepH 12-60VDC, Profinet, AbsC-L

ServoStep MIS is a series of integrated stepper motors with servo control (closed-loop) and up to 3000 RPM.

It consists of NEMA 17..23..34..43 size motors with holding torques from 0.18 Nm up to 25 Nm. All motors are programmable and have 8 I/O points (each can be DI or DO or AI).

Options include:

- incremental (semi-absolute) encoder\*). absolute multiturn encoder
- brake module\*)
- radial or axial\*) connectors
- CANopen
- Ethernet interface w/built-in switch for easy daisy-chaining and all protocols (Profinet. EtherNet/IP. EtherCAT. Sercos. ModbusTCP/UDP. Powerlink).
- Wireless versions are also possible: WLAN or BlueTooth.
- Special shaft versions include double shaft and hollow shaft. contact JVL to learn which combinations are possible.
- Higher IP versions are also available. \*) Depending of other options



### General information

|                            |  |                                     |  |
|----------------------------|--|-------------------------------------|--|
| <b>Description</b>         | Int.StepH 12-60VDC, Profinet, AbsC-L, 4xM12. 2x4pF:Profinet 17pF:8xDIO/AI +RS422+RS485, High Resolution: 409.600 step/rev. ±0.01 RPM, Programmable (incl. current, position & velocity), C-L + Abs Multiturn Enc. 4096 CPR ± 5242 Revs, Ø10x20 mm Round, Shaft: IP42, Motor: IP42, 56.4x124 mm Holding Torque: 2.53 Nm Radial Connector 12-72 VDC Mechanical Power: 316 W, Isolated from earth |                                     |  |
| <b>Manufacture</b>         | JVL  | <b>Motor type</b>                   | Integrated Stepper - Rotating                        |
| <b>Motor resolution</b>    | 409600   | <b>Encoder type</b>                 | H4: H2 incr+absSingleturn and H3 serial/absMultiturn |
| <b>Speed [Rpm]</b>         | 3000.00  | <b>Power Peak [W]</b>               | 316.00   |
| <b>Flange size</b>         | NEMA 23 - 57x57mm  | <b>Shaft size - Front [mm]</b>      | 10.00 mm   |
| <b>Running torque [Nm]</b> | 2.53   | <b>Rated Winding current [A]</b>    | 6.0  |
| <b>Holding torque [Nm]</b> | 2.53   | <b>Connectivity: Without module</b> | Profinet   |
| <b>Integrated PLC</b>      | Yes  | <b>PLC no. of DI/DO/AI</b>          | 8  |
| <b>Closed loop</b>         | Yes  | <b>STO connector</b>                | No   |
| <b>Integrated gear</b>     | No   | <b>Gear ratio</b>                   |  |
| <b>Brake</b>               | No   | <b>Protection House/Shaft</b>       |  |
| <b>Shaft Double</b>        | No   | <b>Paint type</b>                   |  |
| <b>Main supply [V]</b>     | 12-60  | <b>Voltage type - Main</b>          | DC   |



**MIS232T3EPH466**

Int.StepH 12-60VDC, Profinet, AbsC-L

**General information**

|                                       |         |                         |    |
|---------------------------------------|---------|-------------------------|----|
| <b>Control voltage (CVI/O+) [VDC]</b> | 7-28    |                         |    |
| <b>Weight net [kg]</b>                | 1.39    | <b>MTBF 100% [Year]</b> | 13 |
| <b>Weight gross [kg]</b>              | 1.56    | <b>MTBF 30% [Year]</b>  | 15 |
| <b>Software</b>                       | MacTalk |                         |    |
| <b>CE Marked</b>                      | Yes     |                         |    |



|                          |     |
|--------------------------|-----|
| <b>Approval - ROHS-3</b> | Yes |
|--------------------------|-----|



|                    |                                |
|--------------------|--------------------------------|
| <b>Approval UL</b> | Pending. Ask JVL for lead time |
|--------------------|--------------------------------|

|                  |          |                          |    |
|------------------|----------|--------------------------|----|
| <b>Tariff no</b> | 85015100 | <b>Country Of Origin</b> | DK |
|------------------|----------|--------------------------|----|

**Motion Information:**

|  |  |  |  |
|--|--|--|--|
| <b>Velocity Precision [+/-ppm]</b>                   |  | <b>Velocity Resolution [Rpm]</b>                 |  |
| <b>Acceleration / Deceleration Range [Rpm/s]</b>     |  | <b>Acceleration / Deceleration Range [Rpm/s]</b> |  |
| <b>Electronic Gearing Ratio [Range / Resolution]</b> |  |  |  |



## MIS232T3EPH466

Int.StepH 12-60VDC, Profinet, AbsC-L

### Mechanical information

| Motor Type | Length (L)<br>±1.0 [0.0787] | Shaft dia. (D)<br>+0 / -0.013mm[0.000512] |
|------------|-----------------------------|---|
| MIS231S... | 103 [4.06]                  | 6.35 [0.25]                               |
| MIS232S... | 124 [4.88]                  | 6.35 [0.25]                               |
| MIS234S... | 161 [6.34]                  | 10.0 [0.3937]                             |
| MIS231T... | 103 [4.06]                  | 6.35 [0.25]                               |
| MIS232T... | 124 [4.88]                  | 10.0 [0.3937]                             |

[ ] = Inches

This drawing covers only motor type MIS23xS and MIS23xT with radial connectors

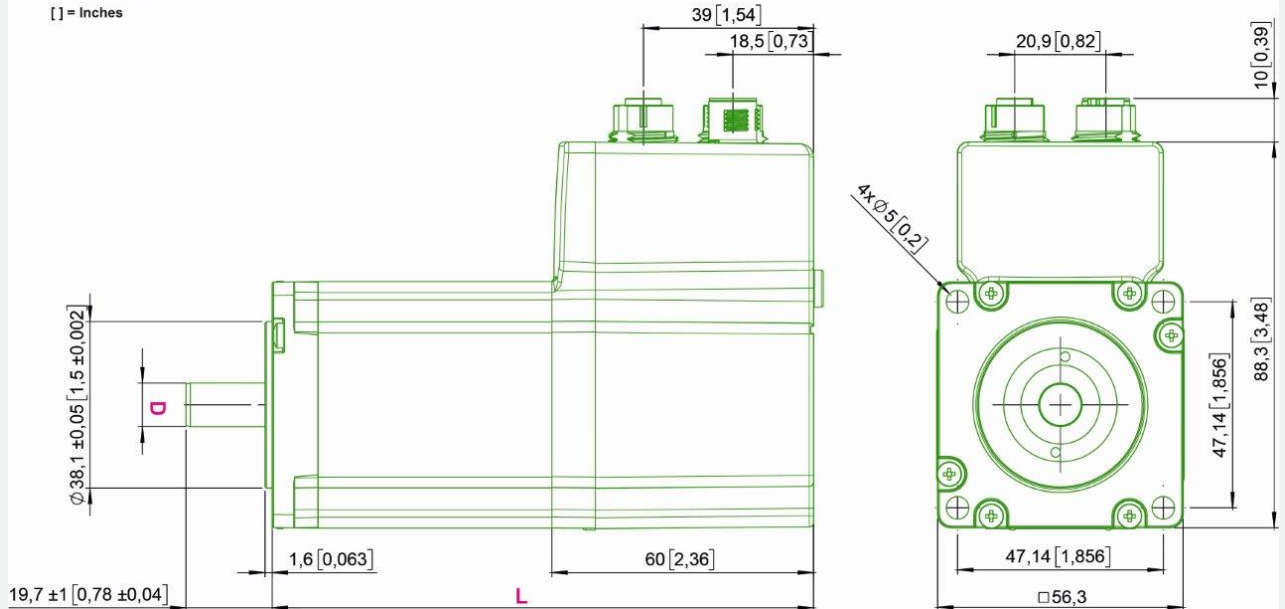

|   |                         |  |                  |
|---|-------------------------|--|------------------|
| <b>Motor length [mm]</b>                | 124.0                   | <b>Motor width [mm]</b>                | 56.4             |
| <b>Motor height [mm]</b>                | 88.1                    | <b>Protection shaft</b>                | IP42             |
| <b>Protection house</b>                 | IP42                    | <b>Flange Rear</b>                     | No               |
| <b>Flange Type Front</b>                |                         | <b>Flange Type Rear</b>                |                  |
| <b>Motor diameter center front [mm]</b> | 38.1                    | <b>Motor diameter center rear [mm]</b> |                  |
| <b>Bolt circle diameter front [mm]</b>  | 66.6                    | <b>Bolt circle diameter front [mm]</b> |                  |
| <b>Mounting holes front [mm]</b>        | 5 mm                    | <b>Mounting holes rear [mm]</b>        |                  |
| <b>Flange Thickness [mm]</b>            | 1.6                     | <b>Flange material</b>                 | Aluminium        |
|   |                         | <b>Shaft Double</b>                    | No               |
| <b>Shaft Type Output</b>                | Round                   | <b>Shaft Type Rear</b>                 |                  |
| <b>Shaft size - Front [mm]</b>          | 10.00 mm                | <b>Shaft size - Rear</b>               | -                |
| <b>Shaft length Front [mm]</b>          | 20.0                    | <b>Shaft length Rear [mm]</b>          |                  |
| <b>Shaft material</b>                   | Stainless steel AISI303 | <b>Shaft Key included</b>              | Key NOT included |
| <b>Shaft Key Dimension</b>              | -                       |  |                  |
| <b>Integrated gear</b>                  | No                      | <b>Gear ratio</b>                      |                  |
| <b>Gear efficiency [%]</b>              | -                       | <b>Gear backlash [ArcMin]</b>          | -                |



**MIS232T3EPH466**

Int.StepH 12-60VDC, Profinet, AbsC-L

**Mechanical information**

|  |   |   |   |
|--|---|---|---|
| <b>Brake</b>                                     | No  | <b>Brake - Go ON time [ms]</b>              | -   |
| <b>Brake Holding torque [Nm]</b>                 | -   | <b>Brake - Go OFF time [ms]</b>             | -   |
| <b>Rotor inertia [kgcm<sup>2</sup>]</b>          | 0.48  | <b>Max inertia factor</b>                   | 40  |
| <b>Precision Motor - Absolute [Deg -/+]</b>      | 0.35  | <b>Precision Motor - Max Load [Deg -/+]</b> |   |
| <b>Precision Motor - Repeatability [Deg -/+]</b> | 0.15  | <b>Step angle [°/full step]</b>             | 1.8°  |
| <b>CAD 2D [PDF]</b>                              | Download  | <b>CAD 3D [STEP]</b>                        | Download  |
| <b>CAD 2D [DWG]</b>                              | No  | <b>CAD 3D [DWG]</b>                         | No  |
| <b>CAD 3D [EASM]</b>                             | Download  | <b>CAD 3D [IGES]</b>                        | No  |
| <b>Datasheet - pdf</b>                           |   | <b>CAD file page</b>                        | Link  |
| <b>User Manual</b>                               | Download  | <b>WEB page</b>                             | Link  |
| <b>Approval UL</b>                               | Pending. Ask JVL for lead time  | <b>STO connector</b>                        | No  |
| <b>Approval - ATEX</b>                           | No  | <b>Approval TÜV - STO</b>                   | No  |
| <b>Oil resistant</b>                             |   |   |   |
| <b>Temperature ambient [°C]</b>                  | 0...40 °C and 0...70 °C with derating of performance                        | <b>Temperature storage</b>                  | -40...70 °C   |
| <b>Humidity working</b>                          | 5...93% non-condensing  | <b>Vibration</b>                            | 5-25 Hz: +/-1.6mm, 25-500Hz: 4G, 1.0 oct./min                                 |
| <b>Shock</b>                                     | 15G, 30ms. 6 x 1000 cycles in +/-X, +/-Y, +/-Z                              | <b>Withstand Voltage</b>                    | 500 VDC between earth and supply ground                                       |
| <b>EMC in general</b>                            | EMC Directive DIR2014/30/EU   | <b>EMC Emission</b>                         | EN61800-3 / EN61000-6-3 / EN61000-6-4 all 2. enviroment                       |
| <b>EMC Immunity</b>                              | En IEC 61800-3 / EN61000-6-1 all 2. enviroment                              | <b>Safety in general</b>                    | LVD DIR2014/35/EU / EL61800 - USA and Canada only MIS34x products are pending |
| <b>Safety wo STO</b>                             | EN60950-1   | <b>Safety w STO</b>                         | EN60950-1 / EN61508-1/-2 SIL3 / ISO13849-1/-2 / ISO62061 / EN61800-5-1/-2     |
| <b>Inviromental</b>                              | IEC 60068-2-27, Test Ea. Shock test   | <b>Inviromental 2</b>                       | IEC 60068-2-6, Test Fc. Vibration test  |
| <b>Inviromental 3</b>                            | IEC 60068-2-2, Test Bd. covers temperaturerise/dry heat                     | <b>Inviromental 4</b>                       | IEC 60068-2-78, Perm. moisture/Damp heat, steady state                        |
| <b>REACH SVHC document</b>                       | REACH-SVHC Statement  | <b>Low voltage Directive</b>                | LVD conformity with EU standard: EN IEC 62368-1:2020/A11:2020                 |
| <b>No Dual Use</b>                               |   |   |   |
| <b>Duty Cycle</b>                                |   | <b>Max Duty Cycle [%]</b>                   |   |
| <b>Front bearing type</b>                        | 6000ZZ  | <b>Rear bearing type</b>                    | 6000ZZ  |
| <b>Axial Load Max: Typical Term</b>              | Axial load Max Typical is a run of 10.800.000 revolutions at indicated load | <b>Axial Load Max: Long Term</b>            | Axial load Max Long is a run of 1.440.000.000 revolutions at indicated load   |
| <b>Axial Load Max: Typical [N] (Bearing)</b>     | 377   | <b>Axial Load Max: Long [N] (Bearing)</b>   | 314   |



**MIS232T3EPH466**

Int.StepH 12-60VDC, Profinet, AbsC-L

**Mechanical information**

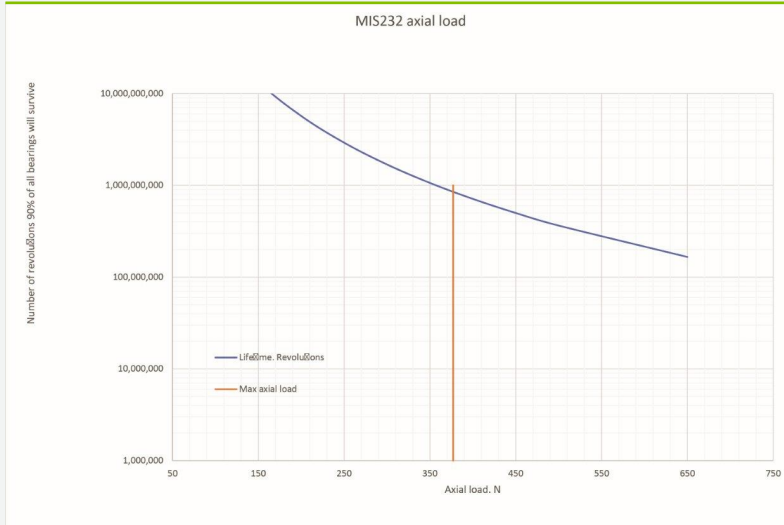

|   |  |  |  |
|---|--|--|--|
| <b>Radial Load Max Typical Term:</b>          | Radial load Max Typical is a run of 10.800.000 revolutions at indicated load | <b>Radial Load Max Long Term:</b>          | Radial load Max Long is a run of 1.440.000.000 revolutions at indicated load |
| <b>Radial Load Max: Typical [N] (Bearing)</b> | 346  | <b>Radial Load Max: Long [N] (Bearing)</b> | 312  |

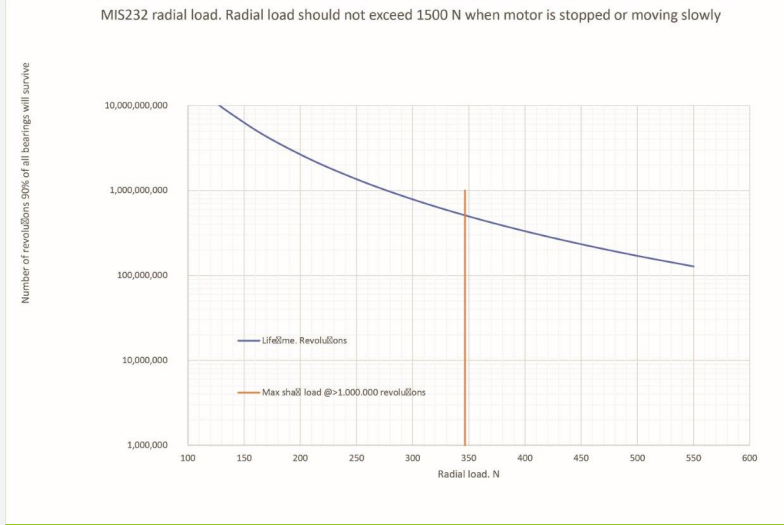

|                                  |    |                        |  |
|----------------------------------|----|------------------------|--|
| <b>Radial load distance [mm]</b> | 10 | <b>Axial play [mm]</b> |  |
| <b>Axial play force [N]</b>      |    | <b>Shaft Seal</b>      |  |



**MIS232T3EPH466**

Int.StepH 12-60VDC, Profinet, AbsC-L

**Connector information**

|                          |     |                          |                                   |
|--------------------------|-----|--------------------------|-----------------------------------|
| <b>Connector 1 label</b> | PWR | <b>Connector 1</b>       | M12 5-pin male A-coded            |
| <b>Connector 2 label</b> | CN2 | <b>Connector 2</b>       | M12 4-pin female D-coded Ethernet |
| <b>Connector 3 label</b> | CN3 | <b>Connector 3</b>       | M12 4-pin female D-coded Ethernet |
| <b>Connector 4 label</b> | CN4 | <b>Connector 4</b>       | M12 17-pin female A-coded         |
| <b>Connector 1 RS485</b> | No  | <b>Connector 2 RS485</b> | No                                |
| <b>Connector 3 RS485</b> | No  | <b>Connector 4 RS485</b> | Yes                               |

**Motor connectors**

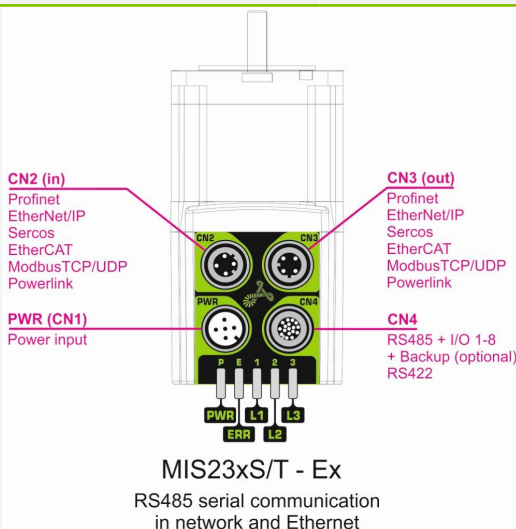

**Picture CN1**

| "PWR" (CN1) - Power input. M12 - 5pin male connector |  |         |                            |                 |
|--|--|---------|----------------------------|-----------------|
| Signal name  | Description  | Pin no. | JVL Cable W11000-M12F5TxxN | Isolation group |
| P+   | Main supply +7-72VDC. Connect with pin 2 *   | 1       | Brown                      | 1               |
| P+   | Main supply +7-72VDC. Connect with pin 1 *   | 2       | White                      | 1               |
| P-   | Main supply ground. Connect with pin 5 *   | 3       | Blue                       | 1               |
| CVI  | Control and user output supply +7-30VDC. <b>DO NOT connect &gt;30V to this terminal!</b> | 4       | Black                      | 1               |
| P-   | Main supply ground. Connect with pin 3 *   | 5       | Grey                       | 1               |

\* Note: P+ and P- are each available at 2 terminals. Make sure that both terminals are connected in order to split the supply current in 2 terminals and thereby avoid an overload of the connector.

**Picture CN2**

| "CN2" - Ethernet In port connector - M12 - 4pin female connector "D" coded |   |         |                            |                            |
|--|---|---------|----------------------------|----------------------------|
| Signal name  | Description                                     | Pin no. | JVL Cable W11046-M12M4S05R | Isolation group (See note) |
| Tx0_P  | Ethernet Transmit channel 0 - positive terminal | 1       | -                          | 2                          |
| Rx0_P  | Ethernet Receive channel 0 - positive terminal  | 2       | -                          | 2                          |
| Tx0_N  | Ethernet Transmit channel 0 - negative terminal | 3       | -                          | 2                          |
| Rx0_N  | Ethernet Receive channel 0 - negative terminal  | 4       | -                          | 2                          |





**MIS232T3EPH466**

Int.StepH 12-60VDC, Profinet, AbsC-L

**Connector information**

**Picture CN3**

| "CN3" - Ethernet Out port connector. M12 - 4 pin female connector "D" coded |   |         |                            |                            |
|---|---|---------|----------------------------|----------------------------|
| Signal name   | Description                                     | Pin no. | JVL Cable WI1046-M12M4S05R | Isolation group (see note) |
| Tx1_P   | Ethernet Transmit channel 1 - positive terminal | 1       | -                          | 3                          |
| Rx1_P   | Ethernet Receive channel 1 - positive terminal  | 2       | -                          | 3                          |
| Tx1_N   | Ethernet Transmit channel 1 - negative terminal | 3       | -                          | 3                          |
| Rx1_N   | Ethernet Receive channel 1 - negative terminal  | 4       | -                          | 3                          |

**Picture CN4**

| "CN4" - RS485 + I/O + Backup (option) connector - M12 - 17pin female connector |   |         |                            |                            |
|--|---|---------|----------------------------|----------------------------|
| Signal name  | Description   | Pin no. | JVL Cable WI1009M12M17TxxN | Isolation group (see note) |
| IO1  | I/O channel 1. Can be used as input or output   | 1       | Brown                      | 1                          |
| GND  | Ground intended to be used together with the other signals in this connector  | 2       | Blue                       | 1                          |
| IO2  | I/O channel 2. Can be used as input or output   | 3       | White                      | 1                          |
| IO3  | I/O channel 3. Can be used as input or output   | 4       | Green                      | 1                          |
| RS422: B1-   | RS422 I/O terminal B-   | 5       | Pink                       | 1                          |
| IO4  | I/O channel 4. Can be used as input or output   | 6       | Yellow                     | 1                          |
| RS422: A1-   | RS422 I/O terminal A-   | 7       | Black                      | 1                          |
| RS422: B1+   | RS422 I/O terminal B+   | 8       | Grey                       | 1                          |
| CVO  | Supply output. Connected internally to the CVI terminal in the PWR connector.<br><b>DO NOT connect &gt;30V to this terminal!</b>  | 9       | Red                        | 1                          |
| RS422: A1+   | RS422 I/O terminal A+   | 10      | Violet                     | 1                          |
| IO5  | I/O channel 5. Can be used as input or output   | 11      | Grey/pink                  | 1                          |
| IO6  | I/O channel 6. Can be used as input or output   | 12      | Red/blue                   | 1                          |
| IO7  | I/O channel 7. Can be used as input or output   | 13      | White/Green                | 1                          |
| IO8  | I/O channel 8. Can be used as input or output   | 14      | Brown/Green                | 1                          |
| RS485: B0-   | RS485 interface. Leave open if unused   | 15      | White/Yellow               | 1                          |
| EXTBACKUP  | Only for motors with the -H3 or -H4 option (abs. multiturn encoder). This terminal can be connected to an external supply.<br><b>Connect to ground (GND) if not used.</b> | 16      | Yellow/brown               | 1                          |
| RS485: A0+   | RS485 interface. Leave open if unused   | 17      | White/grey                 | 1                          |

\* Note: Isolation group indicate which terminals/circuits that a galvanic connected to each other. In other words group 1, 2, 3 and 4 are all fully independently isolated from each other. Group 1 correspond to the housing of the motor which may also be connected to earth via the DC or AC input supply.

**Connector STO** No

**Picture STO Con** -



**MIS232T3EPH466**

Int.StepH 12-60VDC, Profinet, AbsC-L

**Torque, force and Power information**

|                            |       |                            |        |
|----------------------------|-------|----------------------------|--------|
| <b>Supply Volt 1 [V]</b>   |       | <b>Power Peak 1 [W]</b>    |        |
| <b>Supply Volt 2 [V]</b>   | 24    | <b>Power Peak 2 [W]</b>    | 103.00 |
| <b>Supply Volt 3 [V]</b>   | 48    | <b>Power Peak 3 [W]</b>    | 209.00 |
| <b>Supply Volt 4 [V]</b>   | 60    | <b>Power Peak 4 [W]</b>    | 316.00 |
| <b>Holding torque [Nm]</b> | 2.53  | <b>Running torque [Nm]</b> | 2.53   |
| <b>Detent torque [Nm]</b>  | 0.068 |                            |        |

**MIS232T motor torque and shaft power versus speed**

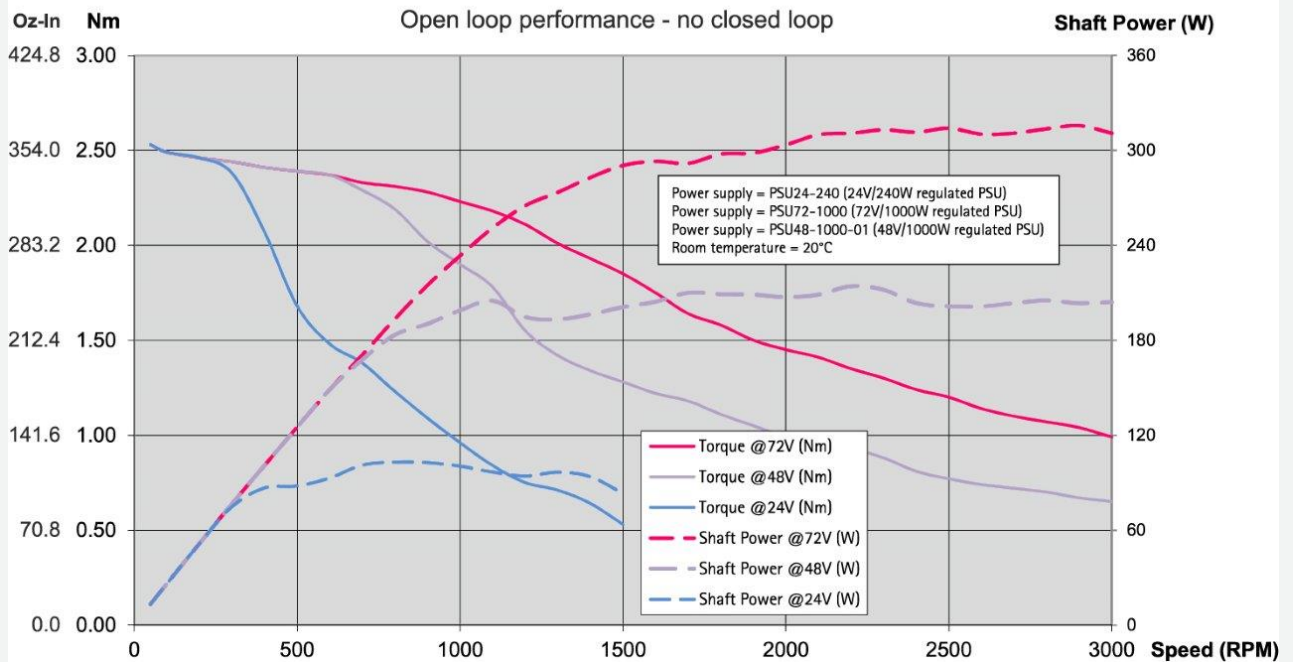





**MIS232T3EPH466**

Int.StepH 12-60VDC, Profinet, AbsC-L

**Electrical information**

|  |  |   |  |
|--|--|---|--|
| <b>Main supply [V]</b>                         | 12-60  | <b>Main supply Min-Max [V]</b>                            | 7-90   |
| <b>Rated motor current [A]</b>                 | 6.2  | <b>Control voltage (CVI/O+) [VDC]</b>                     | 7-28   |
| <b>Control Voltage (CVI) Min-Max [VDC]</b>     | 7-30   | <b>CVI current wo Ethernet and output (12/24VDC) [mA]</b> | 90/55  |
| <b>Current Ethernet option (12/24VDC) [mA]</b> | 120/60                                       | <b>Current brake option [mA]</b>                          | -  |
| <b>Current for 1 Dig. output max [mA]</b>      | 350  | <b>Max current CVI [A]</b>                                |  |
| <b>Dig. Input impedans</b>                     | 30 Kohm                                      | <b>Counter frequency max</b>                              | 12MHz  |
| <b>MTBF 30% [Year]</b>                         | 15   | <b>MTBF 100% [Year]</b>                                   | 13   |
| <b>Motor resolution</b>                        | 409600                                       | <b>Encoder type</b>                                       | H4: H2 incr+absSingleturn and H3 serial/absMultiturn |
| <b>Encoder Resolution (H2)</b>                 | H2 - 4096 Singleturn AbsEnc - Semi multiturn | <b>Encoder Resolution (H3)</b>                            | H3 - 1024 Multiturn AbsEnc                           |
| <b>Encoder revolutions</b>                     | +/-5242                                      | <b>PLC no. of DI/DO/AI</b>                                | 8  |
| <b>Analogue voltage</b>                        | 0-5VDC 12bit                                 |   |  |
| <b>Standard used</b>                           | <b>Standard used 2</b>                       |   |  |
| <b>Resistance [Ohm]</b>                        | <b>Induction</b>                             |   | <b>[mH]</b>  |



**MIS232T3EPH466**

Int.StepH 12-60VDC, Profinet, AbsC-L

**Communication information**

|   |          |                          |     |
|---|----------|--------------------------|-----|
| <b>Software</b>                         | MacTalk  | <b>Connector 2 RS485</b> | No  |
| <b>Connectivity:<br/>Without module</b> | Profinet | <b>Connector 3 RS485</b> | No  |
|   |          | <b>Connector 4 RS485</b> | Yes |

**Motor connectors**

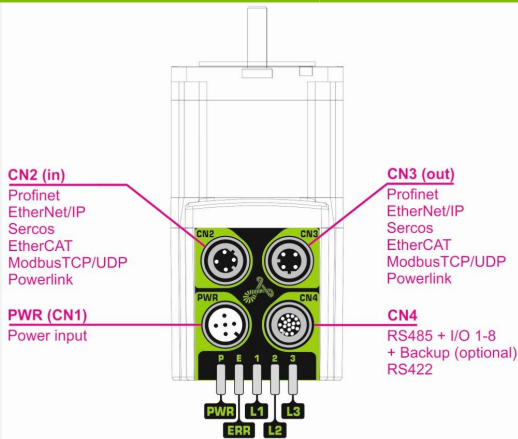

MIS23xS/T - Ex  
RS485 serial communication  
in network and Ethernet

**e-PLC Files**

**Ethernet, PLC demo files**



## MIS232T3EPH466

Int.StepH 12-60VDC, Profinet, AbsC-L

### Cable information

| Item number  | Mount on    | Cable con 1 +Con 1 angle   | Cable application                    | Wires no totally | Cable length [m] |
|--|-------------|--|--------------------------------------|------------------|------------------|
| Item description   |             | Cable con 2 +Con 2 angle   | Cable flexibility                    | Wire [mm2]       | Connector 1 LED  |
| WI1000-M12F5T02N<br>M12 Shl Cable 2m 5 pin Fem 0°, Power                   | Connector 1 | M12 5-pin female A-coded - 180° Straight<br>Open Ended - n/a               | Power/Motor/com<br>Standard          | 5<br>0.32        | 2<br>No          |
| WI1000-M12F5T05N<br>M12 Shl Cable 5m 5 pin Fem 0°, Power                   | Connector 1 | M12 5-pin female A-coded - 180° Straight<br>Open Ended - n/a               | Power/Motor/com<br>Standard          | 5<br>0.32        | 5<br>No          |
| WI1000-M12F5T1.2N<br>M12 Shl Cable 1.2m 5 pin Fem 0°, Power                | Connector 1 | M12 5-pin female A-coded - 180° Straight<br>Open Ended - n/a               | Power/Motor/com<br>Standard          | 5<br>0.32        | 1.2<br>No        |
| WI1000-M12F5T10N<br>M12 Shl Cable 10m 5 pin Fem 0°, Power                  | Connector 1 | M12 5-pin female A-coded - 180° Straight<br>Open Ended - n/a               | Power/Motor/com<br>Standard          | 5<br>0.32        | 10<br>No         |
| WI1000-M12F5T10R<br>M12 Shl Cable 10m 5 pin Fem 0°, Power, High-flex       | Connector 1 | M12 5-pin female A-coded - 180° Straight<br>Open Ended - n/a               | Power/Motor/com<br>Cable Chains - 2D | 5<br>0.34        | 10<br>No         |
| WI1000-M12F5T20N<br>M12 Shl Cable 20m 5 pin Fem 0°, Power                  | Connector 1 | M12 5-pin female A-coded - 180° Straight<br>Open Ended - n/a               | Power/Motor/com<br>Standard          | 5<br>0.32        | 20<br>No         |
| WI1000-M12F5TLT0185<br>M12 shl Cable 3m 5 pin female 0°,PW SPEC            | Connector 1 | M12 5-pin female A-coded - 180° Straight<br>- n/a                          | Power/Motor/com<br>Standard          | 5<br>0.32        | 3<br>No          |
| WI1000-M12F5TM5T1.5N<br>M12 A Code Shl Cable 1.5m 5 pin Female/Male 0° Pow | Connector 1 | M12 5-pin female A-coded - 180° Straight<br>- n/a                          | Power/Motor/com                      |                  | 1.5<br>No        |
| WI1000-M12F5V05N<br>M12 Shl Cable 5m 5 pin Fem 90°, Power                  | Connector 1 | M12 5-pin female A-coded - 90° Angled<br>Open Ended - n/a                  | Power/Motor/com<br>Standard          | 5<br>0.32        | 5<br>No          |
| WI1000-M12F5V05R<br>M12 Shl Cable 5m 5 pin Fem 90°, Power, 3D              | Connector 1 | M12 5-pin female A-coded - 90° Angled<br>- n/a                             | Power/Motor/com                      |                  | 5<br>No          |
| WI1000-M12F5V10N<br>M12 Shl Cable 10 m 5 pin Fem 90°, Power                | Connector 1 | M12 5-pin female A-coded - 90° Angled<br>Open Ended - n/a                  | Power/Motor/com<br>Standard          | 5<br>0.32        | 10<br>No         |
| WI1000-M12F5V20N<br>M12 Shl Cable 20m 5 pin Fem 90°, Power                 | Connector 1 | M12 5-pin female A-coded - 90° Angled<br>Open Ended - n/a                  | Power/Motor/com<br>Standard          | 5<br>0.32        | 20<br>No         |
| WI1000-M12F5W05N<br>M12 Shl Cable 5m LED 5p Fem 90°, Power <50V            | Connector 1 | M12 5-pin female A-coded - 90° Angled<br>Open Ended - n/a                  | Power/Motor/com<br>Standard          | 5<br>0.32        | 5<br>LED         |
| WI1000-M12F5W10N<br>M12 Shl Cable 10m LED 5 p Fem 90°, Power <50V          | Connector 1 | M12 5-pin female A-coded - 90° Angled<br>Open Ended - n/a                  | Power/Motor/com<br>Standard          | 5<br>0.32        | 10<br>LED        |
| WI1000-M12F5W15N<br>M12 Shl Cable 15m LED 5 p Fem 90°, Power <50V          | Connector 1 | M12 5-pin female A-coded - 90° Angled<br>Open Ended - n/a                  | Power/Motor/com<br>Standard          | 5<br>0.32        | 15<br>LED        |
| WI1000-M12F5W20N<br>M12 Shl Cable 20m LED 5 p Fem 90°, Power <50V          | Connector 1 | M12 5-pin female A-coded - 90° Angled<br>Open Ended - n/a                  | Power/Motor/com<br>Standard          | 5<br>0.32        | 20<br>LED        |
| WI1000-M12F5WF5W20N<br>M12 shl cab 20m LED 5 pin female 90',Pow <50V       | Connector 1 | M12 5-pin female A-coded - 90° Angled<br>M12 5-pin female A-coded - n/a    | Power/Motor/com<br>Standard          | 5<br>0.32        | 20<br>LED        |
| WI1005-M12F5TF5T03P<br>M12 Cab 3m, 5p Fem - 5p Fem twistedPair             | Connector 1 | M12 5-pin female A-coded - 180° Straight<br>M12 5-pin female A-coded - n/a | Communication                        |                  | 3<br>No          |
| WI1005-M12F5TM5T2.0N<br>M12 cable 2m, 5 pin female - 5pin male             | Connector 1 | M12 5-pin female A-coded - 180° Straight<br>M12 5-pin male A-coded - n/a   | Communication<br>Standard            |                  | 2<br>0.32<br>No  |
| WI1008-M12F5AG1<br>M12 Con 5p Fem 90° Spring Ø4-8mm cable                  | Connector 1 | M12 5-pin female A-coded - 90° Angled<br>Open Ended - n/a                  | CANopen/DeviceNet                    |                  | 20<br>No         |
| WI1008-M12F5SS1<br>M12 Con 5p Fem 0° Solder assembly                       | Connector 1 | M12 5-pin female A-coded - 180° Straight<br>- n/a                          | CANopen/DeviceNet<br>n/a             | n/a              | Connector<br>No  |
| WI1008-M12F5TG1<br>M12 Con 5p Fem 0° Spring Shield+B222                    | Connector 1 | M12 5-pin female A-coded - 180° Straight<br>- n/a                          | CANopen/DeviceNet<br>n/a             | n/a              | Connector<br>No  |
| WI1008-M12F5VG1<br>M12 Con 5p Fem 90° Spring Shield                        | Connector 1 | M12 5-pin female A-coded - 90° Angled<br>- n/a                             | CANopen/DeviceNet<br>n/a             | n/a              | Connector<br>No  |
| WI1025-M12F5AF5AM5A<br>M12 T-Con 2x Fem 5 p + 1x Male 5 p                  | Connector 1 | M12 5-pin female A-coded - 90° Angled<br>M12 5-pin female A-coded - n/a    |                                      | 5<br>0.32        | No               |
| WI1025-M12F5AM5A<br>M12 Cabinet Feed-through F5p-M5p                       | Connector 1 | M12 5-pin female A-coded - 90° Angled<br>M12 5-pin male A-coded - n/a      |                                      | 5<br>0.32        | No               |
| WI1025-M12F5AM5AF5A<br>M12 T-Con Fem 5p+ Male 5p + Fem 5p NoSh             | Connector 1 | M12 5-pin female A-coded - 90° Angled<br>M12 5-pin male A-coded - n/a      |                                      | 5<br>0.32        | No               |
| WI1025-M12F5VM5VF5V<br>M12 Shl Y-Con 1xMale 5p + 2x Fem 5p CAN             | Connector 1 | M12 5-pin female A-coded - 90° Angled<br>M12 5-pin male A-coded CAN - n/a  |                                      | 5<br>0.32        | No               |
| WI1046-M12M4S.3NRJ45   | Connector 2 | M12 4-pin male D-coded Ethernet - 180° Straight                            | Ethernet                             | 4                | 0.3              |



## MIS232T3EPH466

Int.StepH 12-60VDC, Profinet, AbsC-L

### Cable information

| Item number                                     | Mount on    | Cable con 1 +Con 1 angle                           | Cable application | Wires no totally | Cable length [m] |
|---|-------------|--|-------------------|------------------|------------------|
| Item description                                |             | Cable con 2 +Con 2 angle                           | Cable flexibility | Wire [mm2]       | Connector 1 LED  |
| M12 Cab D-code Ethernet M0°-RJ45, 0,3m, Ø5      |             | RJ45 male - n/a                                    | Standard          | 0.13             | No               |
| WI1046-M12M4S01NRJ45                            | Connector 2 | M12 4-pin male D-coded Ethernet - 180°<br>Straight | Ethernet          | 4                | 1                |
| M12 Cab D-code Ethernet M0°-RJ45, 1,0m, Ø5      |             | RJ45 male - n/a                                    | Standard          | 0.13             | No               |
| WI1046-M12M4S05NRJ45                            | Connector 2 | M12 4-pin male D-coded Ethernet - 180°<br>Straight | Ethernet          | 4                | 5                |
| M12 Cab D-code Ethernet M0°-RJ45, SFTP, 5m, Ø5  |             | RJ45 male - n/a                                    | Standard          | 0.13             | No               |
| WI1046-M12M4S05R                                | Connector 2 | M12 4-pin male D-coded Ethernet - 180°<br>Straight | Ethernet          | 4                | 5                |
| M12 Cab D-code Ethernet M0°, SFTP, 5m Ø7        |             | Open Ended - n/a                                   | Cable chains - 2D | 0.13             | No               |
| WI1046-M12M4S10NRJ45                            | Connector 2 | M12 4-pin male D-coded Ethernet - 180°<br>Straight | Ethernet          | 4                | 10               |
| M12 Cab D-code Ethernet M0°-RJ45, 10m, Ø5       |             | RJ45 male - n/a                                    | Standard          | 0.13             | No               |
| WI1046-M12M4S15NRJ45                            | Connector 2 | M12 4-pin male D-coded Ethernet - 180°<br>Straight | Ethernet          | 4                | 15               |
| M12 Cab D-code Ethernet M0°-RJ45, 15m, RJ45 Ø5  |             | RJ45 male - n/a                                    | Standard          | 0.13             | No               |
| WI1046-M12M4S15R                                | Connector 2 | M12 4-pin male D-coded Ethernet - 180°<br>Straight | Ethernet          | 4                | 15               |
| M12 Cab D-code Ethernet M0°, 15m Ø7             |             | Open Ended - n/a                                   | Cable chains - 2D | 0.13             | No               |
| WI1046-M12M4T.3TRJ45                            | Connector 2 | M12 4-pin male D-coded Ethernet - 180°<br>Straight | Ethernet          | 4                | 0.3              |
| M12 Cab D-code Ethernet M0°-RJ45, 0,3m, RJ45 Ø5 |             | RJ45 male - n/a                                    | Standard          | 0.13             | No               |
| WI1046-M12M4T01TRJ45                            | Connector 2 | M12 4-pin male D-coded Ethernet - 180°<br>Straight | Ethernet          | 4                | 1                |
| M12 Cab D-code Ethernet M0°-RJ45, 1m, RJ45 Ø5   |             | RJ45 male - n/a                                    | Standard          | 0.13             | No               |
| WI1046-M12M4T02NRJ45                            | Connector 2 | M12 4-pin male D-coded Ethernet - 180°<br>Straight | Ethernet          | 4                | 2                |
| M12 Cab D-code Ethernet M0°-RJ45, 2m, Ø5        |             | RJ45 male - n/a                                    | Standard          | 0.13             | No               |
| WI1046-M12M4T05TRJ45                            | Connector 2 | M12 4-pin male D-coded Ethernet - 180°<br>Straight | Ethernet          | 4                | 5                |
| M12 Cab D-code Ethernet M0°-RJ45, 5m, Ø5        |             | RJ45 male - n/a                                    | Standard          | 0.13             | No               |
| WI1046-M12M4T10TRJ45                            | Connector 2 | M12 4-pin male D-coded Ethernet - 180°<br>Straight | Ethernet          | 4                | 10               |
| M12 Cab D-code Ethernet M0°-RJ45, 10m, Ø5       |             | RJ45 male - n/a                                    | Standard          | 0.13             | No               |
| WI1046-M12M4T15TRJ45                            | Connector 2 | M12 4-pin male D-coded Ethernet - 180°<br>Straight | Ethernet          | 4                | 15               |
| M12 Cab D-code Ethernet M0°-RJ45, SFTP, 15m, Ø5 |             | RJ45 male - n/a                                    | Standard          | 0.13             | No               |
| WI1046-M12M4T20TRJ45                            | Connector 2 | M12 4-pin male D-coded Ethernet - 180°<br>Straight | Ethernet          | 4                | 20               |
| M12 Cab D-code Ethernet M0°-RJ45, 20m, Ø5       |             | RJ45 male - n/a                                    | Standard          | 0.13             | No               |
| WI1046-M12M4TM4T.3R                             | Connector 2 | M12 4-pin male D-coded Ethernet - 180°<br>Straight | Ethernet          | 4                | 0.3              |
| M12 Cab D-code Ethernet M0°-M0°, 0,3m, Ø6       |             | M12 4-pin male D-coded Ethernet - n/a              | Robotic - 3D      | 0.14             | No               |
| WI1046-M12M4TM4T.3T                             | Connector 2 | M12 4-pin male D-coded Ethernet - 180°<br>Straight | Ethernet          | 4                | 0.3              |
| M12 Cab D-code Ethernet M0°-M0°, 0,3m, Ø6       |             | M12 4-pin male D-coded Ethernet - n/a              | Standard          | 0.13             | No               |
| WI1046-M12M4TM4T01R                             | Connector 2 | M12 4-pin male D-coded Ethernet - 180°<br>Straight | Ethernet          | 4                | 1                |
| M12 Cab D-code Ethernet M0°-M0°, 1m, Ø7         |             | M12 4-pin male D-coded Ethernet - n/a              | Robotic - 3D      | 0.14             | No               |
| WI1046-M12M4TM4T01T                             | Connector 2 | M12 4-pin male D-coded Ethernet - 180°<br>Straight | Ethernet          | 4                | 1                |
| M12 Cab D-code Ethernet M0°-M0°, 1m, Ø6         |             | M12 4-pin male D-coded Ethernet - n/a              | Standard          | 0.13             | No               |
| WI1046-M12M4TM4T02R                             | Connector 2 | M12 4-pin male D-coded Ethernet - 180°<br>Straight | Ethernet          | 4                | 2                |
| M12 Cab D-code Ethernet M0°-M0°, 2,0m, Ø7       |             | M12 4-pin male D-coded Ethernet - n/a              | Robotic - 3D      | 0.14             | No               |
| WI1046-M12M4TM4T02T                             | Connector 2 | M12 4-pin male D-coded Ethernet - 180°<br>Straight | Ethernet          | 4                | 2                |
| M12 Cab D-code Ethernet M0°-M0°, 2,0m, Ø6       |             | M12 4-pin male D-coded Ethernet - n/a              | Standard          | 0.13             | No               |
| WI1046-M12M4TM4T05R                             | Connector 2 | M12 4-pin male D-coded Ethernet - 180°<br>Straight | Ethernet          | 4                | 5                |
| M12 Cab D-code Ethernet M0°-M0°, 5m, Ø7         |             | M12 4-pin male D-coded Ethernet - n/a              | Robotic - 3D      | 0.14             | No               |
| WI1046-M12M4TM4T05T                             | Connector 2 | M12 4-pin male D-coded Ethernet - 180°<br>Straight | Ethernet          | 4                | 5                |
| M12 Cab D-code Ethernet M0°-M0°, 5m, Ø6         |             | M12 4-pin male D-coded Ethernet - n/a              | Standard          | 0.13             | No               |
| WI1046-M12M4TM4T10R                             | Connector 2 | M12 4-pin male D-coded Ethernet - 180°<br>Straight | Ethernet          | 4                | 10               |
| M12 Cab D-code Ethernet M0°-M0°, 10m, Ø7        |             | M12 4-pin male D-coded Ethernet - n/a              | Robotic - 3D      | 0.14             | No               |
| WI1046-M12M4TM4T10T                             | Connector 2 | M12 4-pin male D-coded Ethernet - 180°<br>Straight | Ethernet          | 4                | 10               |
| M12 Cab D-code Ethernet M0°-M0°, 10m, Ø6        |             | M12 4-pin male D-coded Ethernet - n/a              | Standard          | 0.13             | No               |
| WI1046-M12M4TM4T15R                             | Connector 2 | M12 4-pin male D-coded Ethernet - 180°<br>Straight | Ethernet          | 4                | 15               |
| M12 Cab D-code Ethernet M0°-M0°, 15m, Ø7        |             | M12 4-pin male D-coded Ethernet - n/a              | Robotic - 3D      | 0.14             | No               |



## MIS232T3EPH466

Int.StepH 12-60VDC, Profinet, AbsC-L

### Cable information

| Item number                                     | Mount on    | Cable con 1 +Con 1 angle                        | Cable application | Wires no totally | Cable length [m] |
|---|-------------|---|-------------------|------------------|------------------|
| Item description                                |             | Cable con 2 +Con 2 angle                        | Cable flexibility | Wire [mm2]       | Connector 1 LED  |
| WI1046-M12M4TM4T20R                             | Connector 2 | M12 4-pin male D-coded Ethernet - 180° Straight | Ethernet          | 4                | 20               |
| M12 Cab D-code Ethernet M0°-M0°, 20m, Ø7        |             | M12 4-pin male D-coded Ethernet - n/a           | Robotic - 3D      | 0.14             | No               |
| WI1046-M12M4TM4T20T                             | Connector 2 | M12 4-pin male D-coded Ethernet - 180° Straight | Ethernet          | 4                | 20               |
| M12 Cab D-code Ethernet M0°-M0°, 20m, Ø6        |             | M12 4-pin male D-coded Ethernet - n/a           | Standard          | 0.13             | No               |
| WI1046-M12M4V02TRJ45                            | Connector 2 | M12 4-pin male D-coded Ethernet - 90° Angled    | Ethernet          | 4                | 2                |
| M12 Cab D-code Ethernet M90°-RJ45, 2m, Ø5       |             | RJ45 male - n/a                                 | Standard          | 0.13             | No               |
| WI1046-M12M4V05TRJ45                            | Connector 2 | M12 4-pin male D-coded Ethernet - 90° Angled    | Ethernet          | 4                | 5                |
| M12 Cab D-code Ethernet M90°-RJ45, 5m, Ø6       |             | RJ45 male - n/a                                 | Standard          | 0.13             | No               |
| WI1046-M12M4VM4T.6N                             | Connector 2 | M12 4-pin male D-coded Ethernet - 90° Angled    | Ethernet          | 4                | 0.6              |
| M12 Cab D-code Ethernet M90°-M0°, 0,6m, Ø6      |             | M12 4-pin male D-coded Ethernet - n/a           | Standard          | 0.13             | No               |
| WI1046-M12M4VM4V.6N                             | Connector 2 | M12 4-pin male D-coded Ethernet - 90° Angled    | Ethernet          | 4                | 0.6              |
| M12 Cab D-code Ethernet M90°-M90°, 0,6m, Ø6     |             | M12 4-pin male D-coded Ethernet - n/a           | Standard          | 0.13             | No               |
| WI1048-M12M4TTR1                                | Connector 2 | M12 4-pin male D-coded Ethernet - 180° Straight | Ethernet          |                  | Connector        |
| M12 Con 4 p Male D Code Ethernet PressLock      |             | - n/a   | n/a               |                  | No               |
| WI1046-M12M4S.3NRJ45                            | Connector 3 | M12 4-pin male D-coded Ethernet - 180° Straight | Ethernet          | 4                | 0.3              |
| M12 Cab D-code Ethernet M0°-RJ45, 0,3m, Ø5      |             | RJ45 male - n/a                                 | Standard          | 0.13             | No               |
| WI1046-M12M4S01NRJ45                            | Connector 3 | M12 4-pin male D-coded Ethernet - 180° Straight | Ethernet          | 4                | 1                |
| M12 Cab D-code Ethernet M0°-RJ45, 1,0m, Ø5      |             | RJ45 male - n/a                                 | Standard          | 0.13             | No               |
| WI1046-M12M4S05NRJ45                            | Connector 3 | M12 4-pin male D-coded Ethernet - 180° Straight | Ethernet          | 4                | 5                |
| M12 Cab D-code Ethernet M0°-RJ45, SFTP, 5m, Ø5  |             | RJ45 male - n/a                                 | Standard          | 0.13             | No               |
| WI1046-M12M4S05R                                | Connector 3 | M12 4-pin male D-coded Ethernet - 180° Straight | Ethernet          | 4                | 5                |
| M12 Cab D-code Ethernet M0°, SFTP, 5m Ø7        |             | Open Ended - n/a                                | Cable chains - 2D | 0.13             | No               |
| WI1046-M12M4S10NRJ45                            | Connector 3 | M12 4-pin male D-coded Ethernet - 180° Straight | Ethernet          | 4                | 10               |
| M12 Cab D-code Ethernet M0°-RJ45, 10m, Ø5       |             | RJ45 male - n/a                                 | Standard          | 0.13             | No               |
| WI1046-M12M4S15NRJ45                            | Connector 3 | M12 4-pin male D-coded Ethernet - 180° Straight | Ethernet          | 4                | 15               |
| M12 Cab D-code Ethernet M0°-RJ45, 15m, RJ45 Ø5  |             | RJ45 male - n/a                                 | Standard          | 0.13             | No               |
| WI1046-M12M4S15R                                | Connector 3 | M12 4-pin male D-coded Ethernet - 180° Straight | Ethernet          | 4                | 15               |
| M12 Cab D-code Ethernet M0°, 15m Ø7             |             | Open Ended - n/a                                | Cable chains - 2D | 0.13             | No               |
| WI1046-M12M4T.3TRJ45                            | Connector 3 | M12 4-pin male D-coded Ethernet - 180° Straight | Ethernet          | 4                | 0.3              |
| M12 Cab D-code Ethernet M0°-RJ45, 0,3m, RJ45 Ø5 |             | RJ45 male - n/a                                 | Standard          | 0.13             | No               |
| WI1046-M12M4T01TRJ45                            | Connector 3 | M12 4-pin male D-coded Ethernet - 180° Straight | Ethernet          | 4                | 1                |
| M12 Cab D-code Ethernet M0°-RJ45, 1m, RJ45 Ø5   |             | RJ45 male - n/a                                 | Standard          | 0.13             | No               |
| WI1046-M12M4T02NRJ45                            | Connector 3 | M12 4-pin male D-coded Ethernet - 180° Straight | Ethernet          | 4                | 2                |
| M12 Cab D-code Ethernet M0°-RJ45, 2m, Ø5        |             | RJ45 male - n/a                                 | Standard          | 0.13             | No               |
| WI1046-M12M4T05TRJ45                            | Connector 3 | M12 4-pin male D-coded Ethernet - 180° Straight | Ethernet          | 4                | 5                |
| M12 Cab D-code Ethernet M0°-RJ45, 5m, Ø5        |             | RJ45 male - n/a                                 | Standard          | 0.13             | No               |
| WI1046-M12M4T10TRJ45                            | Connector 3 | M12 4-pin male D-coded Ethernet - 180° Straight | Ethernet          | 4                | 10               |
| M12 Cab D-code Ethernet M0°-RJ45, 10m, Ø5       |             | RJ45 male - n/a                                 | Standard          | 0.13             | No               |
| WI1046-M12M4T15TRJ45                            | Connector 3 | M12 4-pin male D-coded Ethernet - 180° Straight | Ethernet          | 4                | 15               |
| M12 Cab D-code Ethernet M0°-RJ45, SFTP, 15m, Ø5 |             | RJ45 male - n/a                                 | Standard          | 0.13             | No               |
| WI1046-M12M4T20TRJ45                            | Connector 3 | M12 4-pin male D-coded Ethernet - 180° Straight | Ethernet          | 4                | 20               |
| M12 Cab D-code Ethernet M0°-RJ45, 20m, Ø5       |             | RJ45 male - n/a                                 | Standard          | 0.13             | No               |
| WI1046-M12M4TM4T.3R                             | Connector 3 | M12 4-pin male D-coded Ethernet - 180° Straight | Ethernet          | 4                | 0.3              |
| M12 Cab D-code Ethernet M0°-M0°, 0,3m, Ø6       |             | M12 4-pin male D-coded Ethernet - n/a           | Robotic - 3D      | 0.14             | No               |
| WI1046-M12M4TM4T.3T                             | Connector 3 | M12 4-pin male D-coded Ethernet - 180° Straight | Ethernet          | 4                | 0.3              |
| M12 Cab D-code Ethernet M0°-M0°, 0,3m, Ø6       |             | M12 4-pin male D-coded Ethernet - n/a           | Standard          | 0.13             | No               |
| WI1046-M12M4TM4T01R                             | Connector 3 | M12 4-pin male D-coded Ethernet - 180° Straight | Ethernet          | 4                | 1                |
| M12 Cab D-code Ethernet M0°-M0°, 1m, Ø7         |             | M12 4-pin male D-coded Ethernet - n/a           | Robotic - 3D      | 0.14             | No               |
| WI1046-M12M4TM4T01T                             | Connector 3 | M12 4-pin male D-coded Ethernet - 180° Straight | Ethernet          | 4                | 1                |
| M12 Cab D-code Ethernet M0°-M0°, 1m, Ø6         |             | M12 4-pin male D-coded Ethernet - n/a           | Standard          | 0.13             | No               |



## MIS232T3EPH466

Int.StepH 12-60VDC, Profinet, AbsC-L

### Cable information

| Item number                                 | Mount on    | Cable con 1 +Con 1 angle                        | Cable application     | Wires no totally | Cable length [m] |
|---|-------------|---|-----------------------|------------------|------------------|
| Item description                            |             | Cable con 2 +Con 2 angle                        | Cable flexibility     | Wire [mm2]       | Connector 1 LED  |
| WI1046-M12M4TM4T02R                         | Connector 3 | M12 4-pin male D-coded Ethernet - 180° Straight | Ethernet              | 4                | 2                |
| M12 Cab D-code Ethernet M0°-M0°, 2,0m, Ø7   |             | M12 4-pin male D-coded Ethernet - n/a           | Robotic - 3D          | 0.14             | No               |
| WI1046-M12M4TM4T02T                         | Connector 3 | M12 4-pin male D-coded Ethernet - 180° Straight | Ethernet              | 4                | 2                |
| M12 Cab D-code Ethernet M0°-M0°, 2,0m, Ø6   |             | M12 4-pin male D-coded Ethernet - n/a           | Standard              | 0.13             | No               |
| WI1046-M12M4TM4T05R                         | Connector 3 | M12 4-pin male D-coded Ethernet - 180° Straight | Ethernet              | 4                | 5                |
| M12 Cab D-code Ethernet M0°-M0°, 5m, Ø7     |             | M12 4-pin male D-coded Ethernet - n/a           | Robotic - 3D          | 0.14             | No               |
| WI1046-M12M4TM4T05T                         | Connector 3 | M12 4-pin male D-coded Ethernet - 180° Straight | Ethernet              | 4                | 5                |
| M12 Cab D-code Ethernet M0°-M0°, 5m, Ø6     |             | M12 4-pin male D-coded Ethernet - n/a           | Standard              | 0.13             | No               |
| WI1046-M12M4TM4T10R                         | Connector 3 | M12 4-pin male D-coded Ethernet - 180° Straight | Ethernet              | 4                | 10               |
| M12 Cab D-code Ethernet M0°-M0°, 10m, Ø7    |             | M12 4-pin male D-coded Ethernet - n/a           | Robotic - 3D          | 0.14             | No               |
| WI1046-M12M4TM4T10T                         | Connector 3 | M12 4-pin male D-coded Ethernet - 180° Straight | Ethernet              | 4                | 10               |
| M12 Cab D-code Ethernet M0°-M0°, 10m, Ø6    |             | M12 4-pin male D-coded Ethernet - n/a           | Standard              | 0.13             | No               |
| WI1046-M12M4TM4T15R                         | Connector 3 | M12 4-pin male D-coded Ethernet - 180° Straight | Ethernet              | 4                | 15               |
| M12 Cab D-code Ethernet M0°-M0°, 15m, Ø7    |             | M12 4-pin male D-coded Ethernet - n/a           | Robotic - 3D          | 0.14             | No               |
| WI1046-M12M4TM4T20R                         | Connector 3 | M12 4-pin male D-coded Ethernet - 180° Straight | Ethernet              | 4                | 20               |
| M12 Cab D-code Ethernet M0°-M0°, 20m, Ø7    |             | M12 4-pin male D-coded Ethernet - n/a           | Robotic - 3D          | 0.14             | No               |
| WI1046-M12M4TM4T20T                         | Connector 3 | M12 4-pin male D-coded Ethernet - 180° Straight | Ethernet              | 4                | 20               |
| M12 Cab D-code Ethernet M0°-M0°, 20m, Ø6    |             | M12 4-pin male D-coded Ethernet - n/a           | Standard              | 0.13             | No               |
| WI1046-M12M4V02TRJ45                        | Connector 3 | M12 4-pin male D-coded Ethernet - 90° Angled    | Ethernet              | 4                | 2                |
| M12 Cab D-code Ethernet M90°-RJ45, 2m, Ø5   |             | RJ45 male - n/a                                 | Standard              | 0.13             | No               |
| WI1046-M12M4V05TRJ45                        | Connector 3 | M12 4-pin male D-coded Ethernet - 90° Angled    | Ethernet              | 4                | 5                |
| M12 Cab D-code Ethernet M90°-RJ45, 5m, Ø6   |             | RJ45 male - n/a                                 | Standard              | 0.13             | No               |
| WI1046-M12M4VM4T.6N                         | Connector 3 | M12 4-pin male D-coded Ethernet - 90° Angled    | Ethernet              | 4                | 0.6              |
| M12 Cab D-code Ethernet M90°-M0°, 0,6m, Ø6  |             | M12 4-pin male D-coded Ethernet - n/a           | Standard              | 0.13             | No               |
| WI1046-M12M4VM4V.6N                         | Connector 3 | M12 4-pin male D-coded Ethernet - 90° Angled    | Ethernet              | 4                | 0.6              |
| M12 Cab D-code Ethernet M90°-M90°, 0,6m, Ø6 |             | M12 4-pin male D-coded Ethernet - n/a           | Standard              | 0.13             | No               |
| WI1048-M12M4TTR1                            | Connector 3 | M12 4-pin male D-coded Ethernet - 180° Straight | Ethernet              |                  | Connector        |
| M12 Con 4 p Male D Code Ethernet PressLock  |             | - n/a   | n/a                   |                  | No               |
| WI1005-M12M17SAA01                          | Connector 4 | M12 17-pin male A-coded - 180° Straight         | Communication         | n/a              | Connector        |
| M12 17-pin male Axis 1 Without wire         |             | n/a - n/a                                       | n/a                   | n/a              | No               |
| WI1005-M12M17SAA01W                         | Connector 4 | M12 17-pin male A-coded - 180° Straight         | Communication         | n/a              | Connector        |
| M12 17-pin male Axis 1, with wire 1,2m      |             | n/a - n/a                                       | n/a                   | n/a              | No               |
| WI1005-M12M17SAA02                          | Connector 4 | M12 17-pin male A-coded - 180° Straight         | Communication         | n/a              | Connector        |
| M12 17-pin male Axis 2 Without wire         |             | n/a - n/a                                       | n/a                   | n/a              | No               |
| WI1005-M12M17SAA03                          | Connector 4 | M12 17-pin male A-coded - 180° Straight         | Communication         | n/a              | Connector        |
| M12 17-pin male Axis 3 Without wire         |             | n/a - n/a                                       | n/a                   | n/a              | No               |
| WI1005-M12M17SAA04                          | Connector 4 | M12 17-pin male A-coded - 180° Straight         | Communication         | n/a              | Connector        |
| M12 17-pin male Axis 4 Without wire         |             | n/a - n/a                                       | n/a                   | n/a              | No               |
| WI1005-M12M17SAA05                          | Connector 4 | M12 17-pin male A-coded - 180° Straight         | Communication         | n/a              | Connector        |
| M12 17-pin male Axis 5 Without wire         |             | n/a - n/a                                       | n/a                   | n/a              | No               |
| WI1005-M12M17SAA06                          | Connector 4 | M12 17-pin male A-coded - 180° Straight         | Communication         | n/a              | Connector        |
| M12 17-pin male Axis 6 Without wire         |             | n/a - n/a                                       | n/a                   | n/a              | No               |
| WI1005-M12M17SAA06W                         | Connector 4 | M12 17-pin male A-coded - 180° Straight         | Communication         | n/a              | Connector        |
| M12 17-pin male Axis 6 with wire 1,2m       |             | n/a - n/a                                       | n/a                   | n/a              | No               |
| WI1005-M12M17SAA07                          | Connector 4 | M12 17-pin male A-coded - 180° Straight         | Communication         | n/a              | Connector        |
| M12 17-pin male Axis 7 Without wire         |             | n/a - n/a                                       | n/a                   | n/a              | No               |
| WI1005-M12M17SAA08                          | Connector 4 | M12 17-pin male A-coded - 180° Straight         | Communication         | n/a              | Connector        |
| M12 17-pin male Axis 8 Without wire         |             | n/a - n/a                                       | n/a                   | n/a              | No               |
| WI1005-M12M17SAA09                          | Connector 4 | M12 17-pin male A-coded - 180° Straight         | Communication         | n/a              | Connector        |
| M12 17-pin male Axis 9 Without wire         |             | n/a - n/a                                       | n/a                   | n/a              | No               |
| WI1005-M12M17SAA10                          | Connector 4 | M12 17-pin male A-coded - 180° Straight         | Communication         | n/a              | Connector        |
| M12 17-pin male Axis 10 Without wire        |             | n/a - n/a                                       | n/a                   | n/a              | No               |
| WI1008-M12M17SR1                            | Connector 4 | M12 17-pin male A-coded - 180° Straight         | CANopen/DeviceNet n/a |                  | Connector        |





## MIS232T3EPH466

Int.StepH 12-60VDC, Profinet, AbsC-L

### Cable information

| Item number  | Mount on          | Cable con 1 +Con 1 angle   | Cable application              | Wires no totally | Cable length [m] |
|--|-------------------|--|--------------------------------|------------------|------------------|
| Item description   |                   | Cable con 2 +Con 2 angle   | Cable flexibility              | Wire [mm2]       | Connector 1 LED  |
| M12 Con 17p Male 0° Metal housing 5.4-8.2mm cable                          |                   | - n/a  | n/a                            | n/a              | No               |
| WI1009-M12M17T01N<br>M12 Shl Cable 1m 17p Mal 0° MISxx,Ex41 twisted        | Connector 4       | M12 17-pin male A-coded - 180° Straight<br>Open Ended - n/a                | Basic I/O, Com<br>Standard     | 17<br>0.061      | 1<br>No          |
| WI1009-M12M17T05N<br>M12 Shl Cable 5m 17p Mal 0° MISxx,Ex41 twisted        | Connector 4       | M12 17-pin male A-coded - 180° Straight<br>Open Ended - n/a                | Basic I/O, Com<br>Standard     | 17<br>0.061      | 5<br>No          |
| WI1009-M12M17T10R<br>M12 Shl Cable 10m 17p Mal 0° MISxx,Ex41 twisted       | Connector 4       | M12 17-pin male A-coded - 180° Straight<br>Open Ended - n/a                | Basic I/O, Com<br>Robotic - 3D | 17<br>0.061      | 5<br>No          |
| WI1009-M12M17T20N<br>M12 Shl Cable 20m 17p Mal 0° MISxx,Ex41 twisted       | Connector 4       | M12 17-pin male A-coded - 180° Straight<br>Open Ended - n/a                | Basic I/O, Com<br>Standard     | 17<br>0.061      | 20<br>No         |
| WI1009-M12M17TF17T.5<br>M12 Shl Cable.5m Male17p0°-Female 17p0° twist pair | Connector 4       | M12 17-pin male A-coded - 180° Straight<br>M12 17-pin female A-coded - n/a | Basic I/O, Com<br>Standard     | 17<br>0.061      | 0.5<br>No        |
| WI1009-M12M17TF17T01<br>M12 Shl Cable 1m Male17p0°-Female 17p0° twist pair | Connector 4       | M12 17-pin male A-coded - 180° Straight<br>M12 17-pin female A-coded - n/a | Basic I/O, Com<br>Standard     | 17<br>0.061      | 1<br>No          |
| WI1009-M12M17TF17T02<br>M12 Shl Cable 2m Male17p0°-Female 17p0° twist pair | Connector 4       | M12 17-pin male A-coded - 180° Straight<br>M12 17-pin female A-coded - n/a | Basic I/O, Com<br>Standard     | 17<br>0.061      | 2<br>No          |
| WI1009-M12M17TF17T03<br>M12 Shl Cable 3m Male17p0°-Female 17p0° twist pair | Connector 4       | M12 17-pin male A-coded - 180° Straight<br>M12 17-pin female A-coded - n/a | Basic I/O, Com<br>Standard     | 17<br>0.061      | 3<br>No          |
| WI1009-M12M17TF17T04<br>M12 Shl Cable 4m Male17p0°-Female 17p0° twist pair | Connector 4       | M12 17-pin male A-coded - 180° Straight<br>M12 17-pin female A-coded - n/a | Basic I/O, Com<br>Standard     | 17<br>0.061      | 4<br>No          |
| WI1009-M12M17V05N<br>M12 Shl Cable 5m 17p Mal 90° MISxx,Ex41 twisted       | Connector 4       | M12 17-pin male A-coded - 90° Angled<br>Open Ended - n/a                   | Basic I/O, Com<br>Standard     | 17<br>0.061      | 5<br>No          |
| WI1009-M12M17V05R<br>M12 Shl Cable 5m 17p Mal 90° MISxx,Ex41 twisted       | Connector 4       | M12 17-pin male A-coded - 90° Angled<br>- n/a                              | Basic I/O, Com<br>Robotic - 3D |                  | 5<br>No          |
| WI1009-M12M17V10N<br>M12 Shl Cable 10m 17p Mal 90° MISxx,Ex41 twisted      | Connector 4       | M12 17-pin male A-coded - 90° Angled<br>Open Ended - n/a                   | Basic I/O, Com<br>Standard     | 17<br>0.061      | 10<br>No         |
| RS485-M12-1-5-17<br>RS485 M12-17pin DSub, 5m v1.1                          | Connector 4 RS485 | -  |                                |                  |                  |

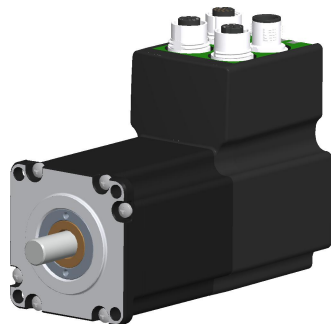
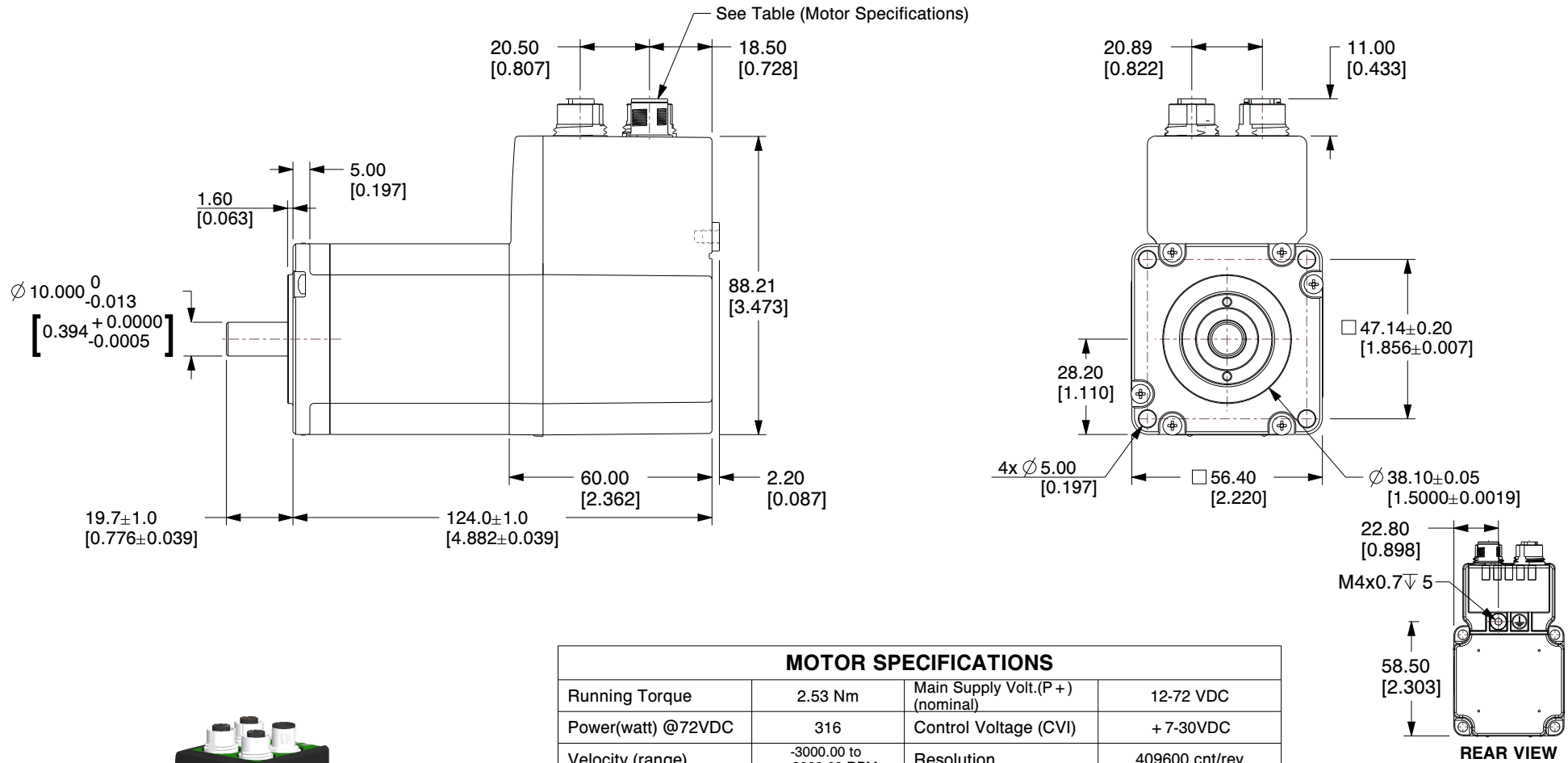

**NOTES:**

1. Operation Modes : Passive, Position, Gear, Velocity.
2. Tolerance for torque and power is  $\pm 10\%$ .
3. Shaft - AISI 303 Stainless steel.
4. Front Bearing: 3202-2RS Double row angular contact.
5. Encoder Type: Internal, magnetic, absolute multturn Closed loop ready.  
Resolution per rev.: Displayed: 409600 counts - internal: 4096 counts.



| MOTOR SPECIFICATIONS                                      |                             |                                       |   |
|---|-----------------------------|---------------------------------------|---|
| Running Torque  | 2.53 Nm                     | Main Supply Volt.(P+)<br>(nominal)    | 12-72 VDC   |
| Power(watt) @72VDC  | 316                         | Control Voltage (CVI)                 | + 7-30VDC   |
| Velocity (range)  | -3000.00 to<br>+3000.00 RPM | Resolution                            | 409600 cnt/rev                                    |
| Velocity (resolution)                                     | 0.01 RPM                    | Protection                            | Shaft: IP42, Motor: IP42                          |
| Velocity (precision)                                      | $\pm 50$ ppm                | Supply Voltage                        | SMC66 Controller 6A 12-72VDC                      |
| Accel./Deceleration<br>(range)                            | 1 - 500000 RPM/s            | Connection                            | Profinet  |
| Accel./Deceleration<br>(resolution)                       | 1 RPM/s                     | Storage temp.                         | -20 to +85°C. (-4 to 185 °F)                      |
| Electronic Gearing<br>(range/resolution)                  | 1/409600 up to<br>409600/1  | Operating<br>Temperature              | Ambient 0 to +40°C<br>(32-104°F)                  |
| Inertia   | 0.48 kgcm <sup>2</sup>      | Connector Type                        | Radial Connector                                  |
| Max. axial shaft force                                    | 15N                         | Weight                                | 1.4 kg  |
| Max. radial shaft force<br>(applied 20 mm from<br>flange) | 75N                         | Analogue Input<br>(Number/Resolution) | 8 inputs available / 12<br>Bit. (0 to +5.00 VDC). |

**JVL A/S**  
Bregnerødvej 127  
DK-3460 Birkerød  
Denmark

  [www.jvl.dk](http://www.jvl.dk)

**PART NUMBER:**  
**MIS232T3EPH466**

**PART DESCRIPTION:**  
**Integrated Stepper Motor**

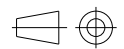
|   |           |       |           |
|---|-----------|-------|-----------|
|  | <b>A4</b> | SCALE | NTS       |
|   |           | UNIT  | MM [Inch] |

Unless specifically stated otherwise, this drawing is the property of JVL A/S and no feature embodied herein may be disclosed except as previously authorized