



MIS171S16ELH266

Int.Step 12-72VDC, Powerlink, EncC-L

ServoStep MIS is a series of integrated stepper motors with servo control (closed-loop) and up to 3000 RPM.

It consists of NEMA 17..23..34..43 size motors with holding torques from 0.18 Nm up to 25 Nm. All motors are programmable and have 8 I/O points (each can be DI or DO or AI).

Options include:

- incremental (semi-absolute) encoder*). absolute multiturn encoder
- brake module*)
- radial or axial*) connectors
- CANopen
- Ethernet interface w/built-in switch for easy daisy-chaining and all protocols (Profinet. EtherNet/IP. EtherCAT. Sercos. ModbusTCP/UDP. Powerlink).
- Wireless versions are also possible: WLAN or BlueTooth.
- Special shaft versions include double shaft and hollow shaft. contact JVL to learn which combinations are possible.
- Higher IP versions are also available. *) Depending of other options



General information

Description	Int.Step 12-72VDC, Powerlink, EncC-L, 4xM12. 2x4pF:Powerlink 17pF:8xDIO/AI +RS422+RS485, High Resolution: 409.600 step/rev. ±0.01 RPM, Programmable (incl. current, position & velocity), Closed-Loop Semi-Abs. Encoder 4096 CPR, Ø5x20 mm Round, Shaft: IP42, Motor: IP42, 43.1x73.5 mm Holding Torque: 0.18 Nm Radial Connector 12-72 VDC Mechanical Power: 48 W, Isolated from earth		
Manufacture	JVL	Motor type	Integrated Stepper - Rotating
Motor resolution	409600	Encoder type	H2 Incremental/abs_singleturn
Speed [Rpm]	3000.00	Power Peak [W]	92.31
Flange size	NEMA 17 - 42x42mm	Shaft size - Front [mm]	5.00 mm
Running torque [Nm]	0.18	Rated Winding current [A]	4.0
Holding torque [Nm]	0.18	Connectivity: Without module	Powerlink
Integrated PLC	Yes	PLC no. of DI/DO/AI	8
Closed loop	Yes	STO connector	No
Integrated gear	No	Gear ratio	
Brake	No	Protection House/Shaft	
Shaft Double	No	Main supply [V]	12-72



MIS171S16ELH266

Int.Step 12-72VDC, Powerlink, EncC-L

General information

Main supply UL [V]	12-60	Voltage type - Main	DC
Control voltage (CVI/O+) [VDC]	7-28		
Weight net [kg]	0.51	MTBF 100% [Year]	13
Weight gross [kg]	0.68	MTBF 30% [Year]	15
Software	MacTalk		
CE Marked	Yes		



Approval - ROHS-3	Yes		
--------------------------	-----	--	--



Approval UL	Pending. Ask JVL for lead time		
--------------------	--------------------------------	--	--

Tariff no	85015100	Country Of Origin	DK
------------------	----------	--------------------------	----

Motion Information:

Velocity Precision [+/-ppm]		Velocity Resolution [Rpm]	
Acceleration / Deceleration Range [Rpm/s]		Acceleration / Deceleration Range [Rpm/s]	
Electronic Gearing Ratio [Range / Resolution]			



MIS171S16ELH266

Int.Step 12-72VDC, Powerlink, Enc-C-L

Mechanical information

Paint type

Motor Type	Length (L1) ±2.0 [0.0787]	Length (L2) ±2.0 [0.0787]	Shaft length and form (L3) +0 / -0.013mm(0.000512)	Shaft dia. (D) +0 / -0.013mm(0.000512)
MIS171S16..	73.5 [2.89]	0.8 [0.03]	20.0 [0.79] Round	5.0 [0.19]
MIS173S8..	85.2 [3.35]	12.5 [0.49]	20.0 [0.79] D-cut	6.35 [0.25]
MIS173S16..	85.2 [3.35]	12.5 [0.49]	20.0 [0.79] Round	5.0 [0.19]
MIS176S8..	106 [4.17]	33.3 [1.31]	20.0 [0.79] D-cut	6.35 [0.25]
MIS176S35..	106 [4.17]	33.3 [1.31]	24.0 [0.94] Keyway	8.0 [0.31]
MIS176S75..	106 [4.17]	33.3 [1.31]	24.0 [0.94] D-cut	6.35 [0.25]

[] = Inches

This drawing covers only motor type MIS17xS with radial connectors

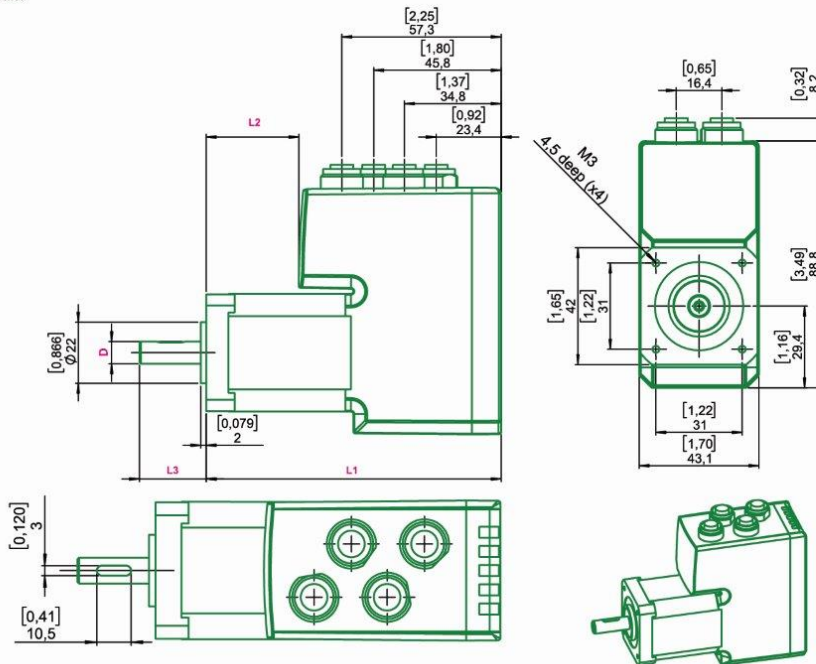

Motor length [mm]	73.5	Motor width [mm]	43.1
Motor height [mm]	88.8	Protection house	IP42
Protection house	IP42	Protection shaft	IP42
Flange Type Front		Flange Type Rear	No
Motor diameter center front [mm]	22.0	Motor diameter center rear [mm]	
Bolt circle diameter front [mm]	43.8	Bolt circle diameter front [mm]	
Mounting holes front [mm]	M3	Mounting holes rear [mm]	
Flange Thickness [mm]		Flange material	Aluminium
Shaft Type Output	Round	Shaft Double	No
Shaft size - Front [mm]	5.00 mm	Shaft Type Rear	
Shaft length Front [mm]	20.0	Shaft size - Rear	-
Shaft material	Stainless steel AISI303	Shaft length Rear [mm]	
Shaft Key Dimension	-	Shaft Key included	Key NOT included
Integrated gear	No	Gear ratio	



MIS171S16ELH266

Int.Step 12-72VDC, Powerlink, EncC-L

Mechanical information

Gear efficiency [%]	-	Gear backlash [ArcMin]	-
Brake	No	Brake - Go ON time [ms]	-
Brake Holding torque [Nm]	-	Brake - Go OFF time [ms]	-
Rotor inertia [kgcm²]	0.020	Max inertia factor	40
Precision Motor - Absolute [Deg -/+]	0.35	Precision Motor - Max Load [Deg -/+]	
Precision Motor - Repeatability [Deg -/+]	0.15	Step angle [°/full step]	1.8°
CAD 2D [PDF]	Download	CAD 3D [STEP]	Download
CAD 2D [DWG]	No	CAD 3D [DWG]	No
CAD 3D [EASM]	No	CAD 3D [IGES]	No
Datasheet - pdf		CAD file page	Link
User Manual	Download	WEB page	Link
Approval UL	Pending. Ask JVL for lead time	STO connector	No
Approval - ATEX	No	Approval TÜV - STO	No
Oil resistant			
Temperature ambient [°C]	0...40 °C and 0...70 °C with derating of performance	Temperature storage	-40...70 °C
Humidity working	5...93% non-condensing	Vibration	5-25 Hz: +/-1.6mm, 25-500Hz: 4G, 1.0 oct./min
Shock	15G, 30ms. 6 x 1000 cycles in +/-X, +/-Y, +/-Z	Withstand Voltage	500 VDC between earth and supply ground
EMC in general	EMC Directive DIR2014/30/EU	EMC Emission	EN61800-3 / EN61000-6-3 / EN61000-6-4 all 2. enviroment
EMC Immunity	En IEC 61800-3 / EN61000-6-1 all 2. enviroment	Safety in general	LVD DIR2014/35/EU / EL61800 - USA and Canada only MIS34x products are pending
Safety wo STO	EN60950-1	Safety w STO	EN60950-1 / EN61508-1/-2 SIL3 / ISO13849-1/-2 / ISO62061 / EN61800-5-1/-2
Inviromental	IEC 60068-2-27, Test Ea. Shock test	Inviromental 2	IEC 60068-2-6, Test Fc. Vibration test
Inviromental 3	IEC 60068-2-2, Test Bd. covers temperaturerise/dry heat	Inviromental 4	IEC 60068-2-78, Perm. moisture/Damp heat, steady state
REACH SVHC document	REACH-SVHC Statement	Low voltage Directive	LVD conformity with EU standard: EN IEC 62368-1:2020/A11:2020
No Dual Use			
Duty Cycle		Max Duty Cycle [%]	
Front bearing type	698ZZ	Rear bearing type	698ZZ
Axial Load Max: Typical Term	Axial load Max Typical is a run of 14.400.000 revolutions at indicated load	Axial Load Max: Long Term	Axial load Max Long is a run of 1.440.000.000 revolutions at indicated load
Axial Load Max: Typical [N] (Bearing)	174	Axial Load Max: Long [N] (Bearing)	96



MIS171S16ELH266

Int.Step 12-72VDC, Powerlink, EncC-L

Mechanical information

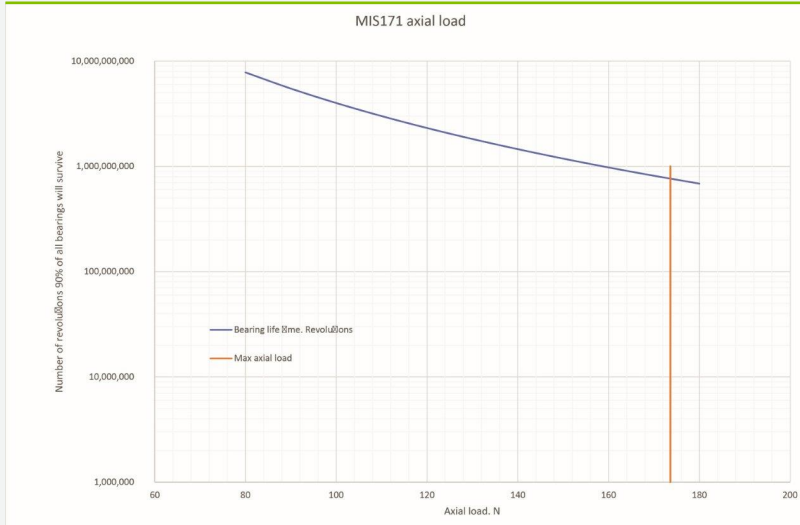

Radial Load Max Typical Term:	Radial load Max Typical is a run of 14.400.000 revolutions at indicated load	Radial Load Max Long Term:	Radial load Max Long is a run of 1.440.000.000 revolutions at indicated load
Radial Load Max: Typical [N] (Bearing)	202	Radial Load Max: Long [N] (Bearing)	140

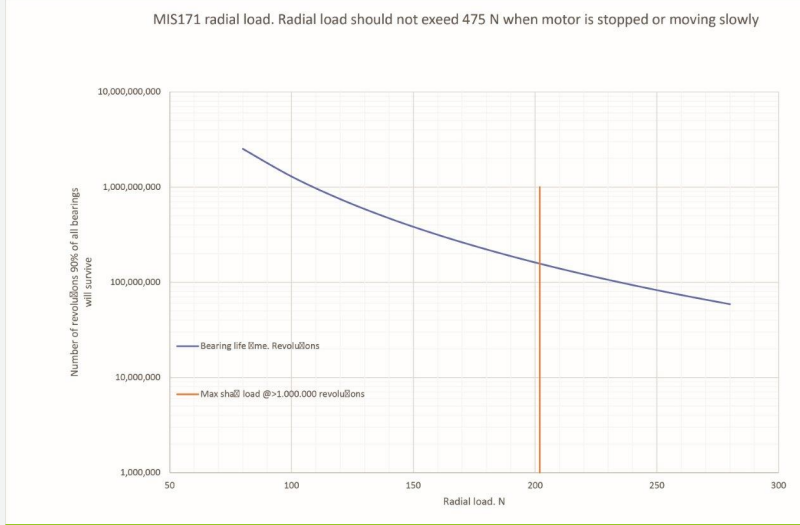

Radial load distance [mm]	10	Axial play [mm]	0.08
Axial play force [N]	4	Shaft Seal	



MIS171S16ELH266

Int.Step 12-72VDC, Powerlink, EncC-L

Connector information

Connector 1 label	PWR	Connector 1	M12 5-pin male A-coded
Connector 2 label	CN2	Connector 2	M12 4-pin female D-coded Ethernet
Connector 3 label	CN3	Connector 3	M12 4-pin female D-coded Ethernet
Connector 4 label	CN4	Connector 4	M12 17-pin female A-coded
Connector 1 RS485	No	Connector 2 RS485	No
Connector 3 RS485	No	Connector 4 RS485	Yes

Motor connectors

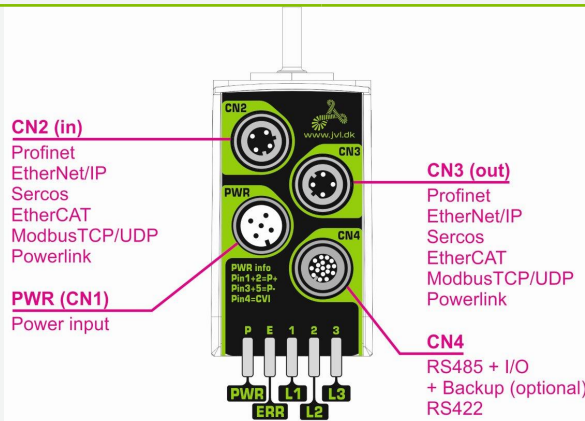

MIS17xS - Ex

RS485 serial communication
in network and Ethernet

Picture CN1

"PWR" (CN1) - Power input. M12 - 5pin male connector				
Signal name	Description	Pin no.	JVL Cable W11000-M12F5TxxN	Isolation group
P+	Main supply +7-72VDC. Connect with pin 2 *	1	Brown	1
P+	Main supply +7-72VDC. Connect with pin 1 *	2	White	1
P-	Main supply ground. Connect with pin 5 *	3	Blue	1
CVI	Control and user output supply +7-30VDC. DO NOT connect >30V to this terminal!	4	Black	1
P-	Main supply ground. Connect with pin 3 *	5	Grey	1

* Note: P+ and P- are each available at 2 terminals. Make sure that both terminals are connected in order to split the supply current in 2 terminals and thereby avoid an overload of the connector.

Picture CN2

"CN2" - Ethernet In port connector - M12 - 4pin female connector "D" coded				
Signal name	Description	Pin no.	JVL Cable W11046-M12M4S05R	Isolation group (See note)
Tx0_P	Ethernet Transmit channel 0 - positive terminal	1	-	2
Rx0_P	Ethernet Receive channel 0 - positive terminal	2	-	2
Tx0_N	Ethernet Transmit channel 0 - negative terminal	3	-	2
Rx0_N	Ethernet Receive channel 0 - negative terminal	4	-	2



MIS171S16ELH266

Int.Step 12-72VDC, Powerlink, EncC-L

Connector information

Picture CN3

"CN3" - Ethernet Out port connector. M12 - 4 pin female connector "D" coded				
Signal name	Description	Pin no.	JVL Cable WI1046-M12M4S05R	Isolation group (see note)
Tx1_P	Ethernet Transmit channel 1 - positive terminal	1	-	3
Rx1_P	Ethernet Receive channel 1 - positive terminal	2	-	3
Tx1_N	Ethernet Transmit channel 1 - negative terminal	3	-	3
Rx1_N	Ethernet Receive channel 1 - negative terminal	4	-	3

Picture CN4

"CN4" - RS485 + I/O + Backup (option) connector - M12 - 17pin female connector				
Signal name	Description	Pin no.	JVL Cable WI1009M12 M17TxxN	Isolation group (see note)
IO1	I/O channel 1. Can be used as input or output	1	Brown	1
GND	Ground intended to be used together with the other signals in this connector	2	Blue	1
IO2	I/O channel 2. Can be used as input or output	3	White	1
IO3	I/O channel 3. Can be used as input or output	4	Green	1
RS422: B1-	RS422 I/O terminal B-	5	Pink	1
IO4	I/O channel 4. Can be used as input or output	6	Yellow	1
RS422: A1-	RS422 I/O terminal A-	7	Black	1
RS422: B1+	RS422 I/O terminal B+	8	Grey	1
CVO	Supply output. Connected internally to the CVI terminal in the PWR connector. DO NOT connect >30V to this terminal!	9	Red	1
RS422: A1+	RS422 I/O terminal A+	10	Violet	1
IO5	I/O channel 5. Can be used as input or output	11	Grey/pink	1
IO6	I/O channel 6. Can be used as input or output	12	Red/blue	1
IO7	I/O channel 7. Can be used as input or output	13	White/Green	1
IO8	I/O channel 8. Can be used as input or output	14	Brown/Green	1
RS485: B0-	RS485 interface. Leave open if unused	15	White/Yellow	1
EXTBACKUP	Only for motors with the -H3 or -H4 option (abs. multiturn encoder). This terminal can be connected to an external supply. Connect to ground (GND) if not used.	16	Yellow/brown	1
RS485: A0+	RS485 interface. Leave open if unused	17	White/grey	1

* Note: Isolation group indicate which terminals/circuits that a galvanic connected to each other. In other words group 1, 2, 3 and 4 are all fully independently isolated from each other. Group 1 correspond to the housing of the motor which may also be connected to earth via the DC or AC input supply.

Connector STO No

Picture STO Con -



MIS171S16ELH266

Int.Step 12-72VDC, Powerlink, EncC-L

Torque, force and Power information

Supply Volt 1 [V]	12	Power Peak 1 [W]	34.60
Supply Volt 2 [V]	24	Power Peak 2 [W]	72.46
Supply Volt 3 [V]	48	Power Peak 3 [W]	91.37
Supply Volt 4 [V]	72	Power Peak 4 [W]	92.31
Holding torque [Nm]	0.18	Running torque [Nm]	0.18
Detent torque [Nm]			

MIS171S motor torque versus speed and supply voltage

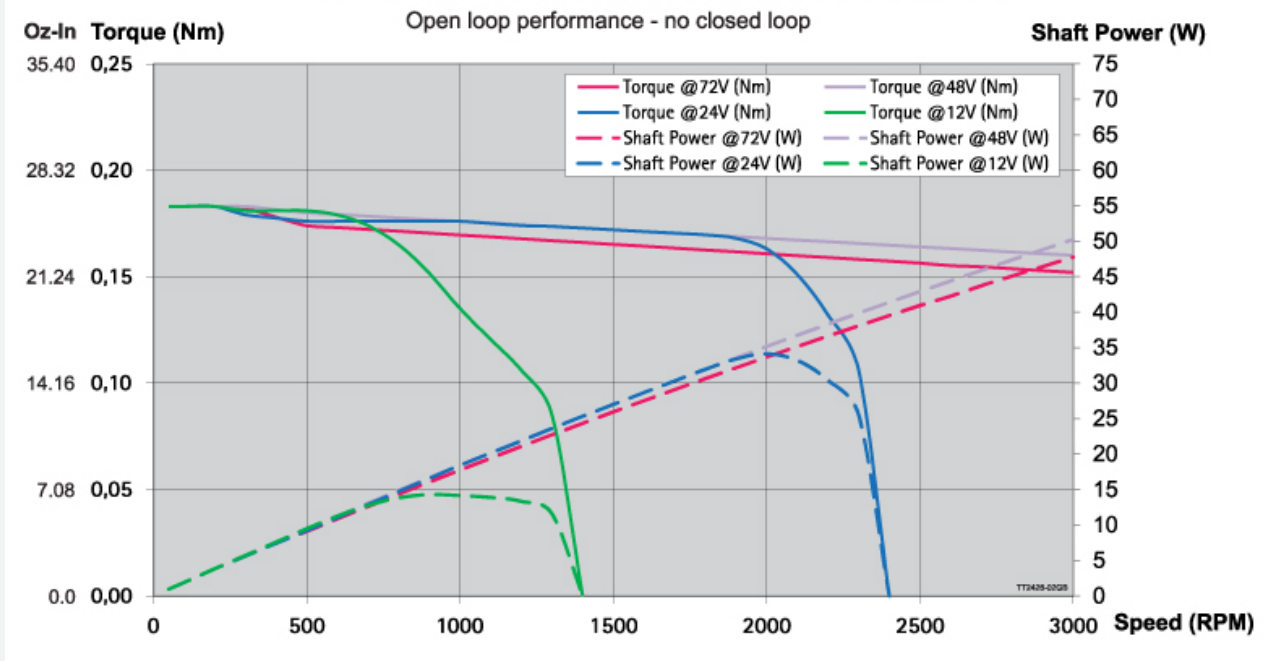



MIS171S16ELH266

Int.Step 12-72VDC, Powerlink, EncC-L

Electrical information

Main supply [V]	12-72	Main supply Min-Max [V]	7-90
Main supply UL [V]	12-60	Main supply Max UL [V]	7-60
Rated motor current [A]	2.7	Control voltage (CVI/O+) [VDC]	7-28
Control Voltage (CVI) Min-Max [VDC]	7-30	CVI current wo Ethernet and output (12/24VDC) [mA]	90/55
Current Ethernet option (12/24VDC) [mA]	120/60	Current brake option [mA]	-
Current for 1 Dig. output - 350 max [mA]		Max current CVI [A]	
Dig. Input impedans	30 Kohm	Counter frequency max	12MHz
MTBF 30% [Year]	15	MTBF 100% [Year]	13
Motor resolution	409600	Encoder type	H2 Incremental/abs_singleturn
Encoder Resolution (H2)	H2 - 4096 Singleturn AbsEnc - Semi multiturn	Encoder Resolution (H3)	-
Encoder revolutions	+/-5242	PLC no. of DI/DO/AI	8
Analogue voltage	0-5VDC 12bit		
Standard used		Standard used 2	
Resistance [Ohm]		Induction [mH]	



MIS171S16ELH266

Int.Step 12-72VDC, Powerlink, EncC-L

Communication information

Software	MacTalk	Connector 2 RS485	No
Connectivity: Without module	Powerlink	Connector 3 RS485	No
		Connector 4 RS485	Yes

Motor connectors

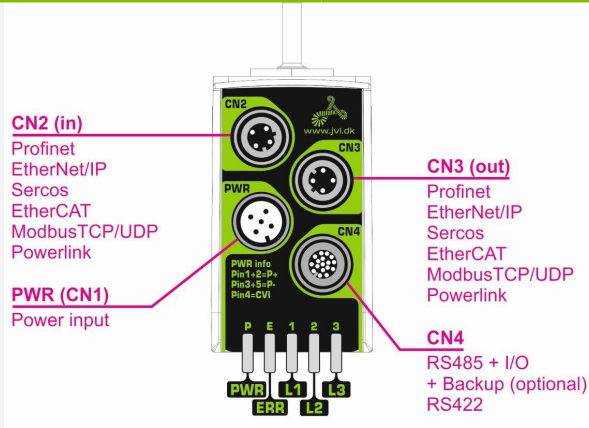

MIS17xS - Ex

RS485 serial communication
in network and Ethernet

e-PLC Files

Ethernet, PLC demo files



MIS171S16ELH266

Int.Step 12-72VDC, Powerlink, EncC-L

Cable information

Item number	Mount on	Cable con 1 +Con 1 angle	Cable application	Wires no totally	Cable length [m]
Item description		Cable con 2 +Con 2 angle	Cable flexibility	Wire [mm2]	Connector 1 LED
WI1000-M12F5T02N M12 Shl Cable 2m 5 pin Fem 0°, Power	Connector 1	M12 5-pin female A-coded - 180° Straight Open Ended - n/a	Power/Motor/com Standard	5 0.32	2 No
WI1000-M12F5T05N M12 Shl Cable 5m 5 pin Fem 0°, Power	Connector 1	M12 5-pin female A-coded - 180° Straight Open Ended - n/a	Power/Motor/com Standard	5 0.32	5 No
WI1000-M12F5T1.2N M12 Shl Cable 1.2m 5 pin Fem 0°, Power	Connector 1	M12 5-pin female A-coded - 180° Straight Open Ended - n/a	Power/Motor/com Standard	5 0.32	1.2 No
WI1000-M12F5T10N M12 Shl Cable 10m 5 pin Fem 0°, Power	Connector 1	M12 5-pin female A-coded - 180° Straight Open Ended - n/a	Power/Motor/com Standard	5 0.32	10 No
WI1000-M12F5T10R M12 Shl Cable 10m 5 pin Fem 0°, Power, High-flex	Connector 1	M12 5-pin female A-coded - 180° Straight Open Ended - n/a	Power/Motor/com Cable Chains - 2D	5 0.34	10 No
WI1000-M12F5T20N M12 Shl Cable 20m 5 pin Fem 0°, Power	Connector 1	M12 5-pin female A-coded - 180° Straight Open Ended - n/a	Power/Motor/com Standard	5 0.32	20 No
WI1000-M12F5TLT0185 M12 shl Cable 3m 5 pin female 0°,PW SPEC	Connector 1	M12 5-pin female A-coded - 180° Straight - n/a	Power/Motor/com Standard	5 0.32	3 No
WI1000-M12F5TM5T1.5N M12 A Code Shl Cable 1.5m 5 pin Female/Male 0° Pow	Connector 1	M12 5-pin female A-coded - 180° Straight - n/a	Power/Motor/com		1.5 No
WI1000-M12F5V05N M12 Shl Cable 5m 5 pin Fem 90°, Power	Connector 1	M12 5-pin female A-coded - 90° Angled Open Ended - n/a	Power/Motor/com Standard	5 0.32	5 No
WI1000-M12F5V05R M12 Shl Cable 5m 5 pin Fem 90°, Power, 3D	Connector 1	M12 5-pin female A-coded - 90° Angled - n/a	Power/Motor/com		5 No
WI1000-M12F5V10N M12 Shl Cable 10 m 5 pin Fem 90°, Power	Connector 1	M12 5-pin female A-coded - 90° Angled Open Ended - n/a	Power/Motor/com Standard	5 0.32	10 No
WI1000-M12F5V20N M12 Shl Cable 20m 5 pin Fem 90°, Power	Connector 1	M12 5-pin female A-coded - 90° Angled Open Ended - n/a	Power/Motor/com Standard	5 0.32	20 No
WI1000-M12F5W05N M12 Shl Cable 5m LED 5p Fem 90°, Power <50V	Connector 1	M12 5-pin female A-coded - 90° Angled Open Ended - n/a	Power/Motor/com Standard	5 0.32	5 LED
WI1000-M12F5W10N M12 Shl Cable 10m LED 5 p Fem 90°, Power <50V	Connector 1	M12 5-pin female A-coded - 90° Angled Open Ended - n/a	Power/Motor/com Standard	5 0.32	10 LED
WI1000-M12F5W15N M12 Shl Cable 15m LED 5 p Fem 90°, Power <50V	Connector 1	M12 5-pin female A-coded - 90° Angled Open Ended - n/a	Power/Motor/com Standard	5 0.32	15 LED
WI1000-M12F5W20N M12 Shl Cable 20m LED 5 p Fem 90°, Power <50V	Connector 1	M12 5-pin female A-coded - 90° Angled Open Ended - n/a	Power/Motor/com Standard	5 0.32	20 LED
WI1000-M12F5WF5W20N M12 shl cab 20m LED 5 pin female 90',Pow <50V	Connector 1	M12 5-pin female A-coded - 90° Angled M12 5-pin female A-coded - n/a	Power/Motor/com Standard	5 0.32	20 LED
WI1005-M12F5TF5T03P M12 Cab 3m, 5p Fem - 5p Fem twistedPair	Connector 1	M12 5-pin female A-coded - 180° Straight M12 5-pin female A-coded - n/a	Communication		3 No
WI1005-M12F5TM5T2.0N M12 cable 2m, 5 pin female - 5pin male	Connector 1	M12 5-pin female A-coded - 180° Straight M12 5-pin male A-coded - n/a	Communication Standard		2 No
WI1008-M12F5AG1 M12 Con 5p Fem 90° Spring Ø4-8mm cable	Connector 1	M12 5-pin female A-coded - 90° Angled Open Ended - n/a	CANopen/DeviceNet		20 No
WI1008-M12F5SS1 M12 Con 5p Fem 0° Solder assembly	Connector 1	M12 5-pin female A-coded - 180° Straight - n/a	CANopen/DeviceNet n/a	n/a	Connector No
WI1008-M12F5TG1 M12 Con 5p Fem 0° Spring Shield+B222	Connector 1	M12 5-pin female A-coded - 180° Straight - n/a	CANopen/DeviceNet n/a	n/a	Connector No
WI1008-M12F5VG1 M12 Con 5p Fem 90° Spring Shield	Connector 1	M12 5-pin female A-coded - 90° Angled - n/a	CANopen/DeviceNet n/a	n/a	Connector No
WI1025-M12F5AF5AM5A M12 T-Con 2x Fem 5 p + 1x Male 5 p	Connector 1	M12 5-pin female A-coded - 90° Angled M12 5-pin female A-coded - n/a		5 0.32	No
WI1025-M12F5AM5A M12 Cabinet Feed-through F5p-M5p	Connector 1	M12 5-pin female A-coded - 90° Angled M12 5-pin male A-coded - n/a		5 0.32	No
WI1025-M12F5AM5AF5A M12 T-Con Fem 5p+ Male 5p + Fem 5p NoSh	Connector 1	M12 5-pin female A-coded - 90° Angled M12 5-pin male A-coded - n/a		5 0.32	No
WI1025-M12F5VM5VF5V M12 Shl Y-Con 1xMale 5p + 2x Fem 5p CAN	Connector 1	M12 5-pin female A-coded - 90° Angled M12 5-pin male A-coded CAN - n/a		5 0.32	No
WI1046-M12M4S.3NRJ45	Connector 2	M12 4-pin male D-coded Ethernet - 180° Straight	Ethernet	4	0.3



MIS171S16ELH266

Int.Step 12-72VDC, Powerlink, EncC-L

Cable information

Item number	Mount on	Cable con 1 +Con 1 angle	Cable application	Wires no totally	Cable length [m]
Item description		Cable con 2 +Con 2 angle	Cable flexibility	Wire [mm2]	Connector 1 LED
M12 Cab D-code Ethernet M0°-RJ45, 0,3m, Ø5		RJ45 male - n/a	Standard	0.13	No
WI1046-M12M4S01NRJ45	Connector 2	M12 4-pin male D-coded Ethernet - 180° Straight	Ethernet	4	1
M12 Cab D-code Ethernet M0°-RJ45, 1,0m, Ø5		RJ45 male - n/a	Standard	0.13	No
WI1046-M12M4S05NRJ45	Connector 2	M12 4-pin male D-coded Ethernet - 180° Straight	Ethernet	4	5
M12 Cab D-code Ethernet M0°-RJ45, SFTP, 5m, Ø5		RJ45 male - n/a	Standard	0.13	No
WI1046-M12M4S05R	Connector 2	M12 4-pin male D-coded Ethernet - 180° Straight	Ethernet	4	5
M12 Cab D-code Ethernet M0°, SFTP, 5m Ø7		Open Ended - n/a	Cable chains - 2D	0.13	No
WI1046-M12M4S10NRJ45	Connector 2	M12 4-pin male D-coded Ethernet - 180° Straight	Ethernet	4	10
M12 Cab D-code Ethernet M0°-RJ45, 10m, Ø5		RJ45 male - n/a	Standard	0.13	No
WI1046-M12M4S15NRJ45	Connector 2	M12 4-pin male D-coded Ethernet - 180° Straight	Ethernet	4	15
M12 Cab D-code Ethernet M0°-RJ45, 15m, RJ45 Ø5		RJ45 male - n/a	Standard	0.13	No
WI1046-M12M4S15R	Connector 2	M12 4-pin male D-coded Ethernet - 180° Straight	Ethernet	4	15
M12 Cab D-code Ethernet M0°, 15m Ø7		Open Ended - n/a	Cable chains - 2D	0.13	No
WI1046-M12M4T.3TRJ45	Connector 2	M12 4-pin male D-coded Ethernet - 180° Straight	Ethernet	4	0.3
M12 Cab D-code Ethernet M0°-RJ45, 0,3m, RJ45 Ø5		RJ45 male - n/a	Standard	0.13	No
WI1046-M12M4T01TRJ45	Connector 2	M12 4-pin male D-coded Ethernet - 180° Straight	Ethernet	4	1
M12 Cab D-code Ethernet M0°-RJ45, 1m, RJ45 Ø5		RJ45 male - n/a	Standard	0.13	No
WI1046-M12M4T02NRJ45	Connector 2	M12 4-pin male D-coded Ethernet - 180° Straight	Ethernet	4	2
M12 Cab D-code Ethernet M0°-RJ45, 2m, Ø5		RJ45 male - n/a	Standard	0.13	No
WI1046-M12M4T05TRJ45	Connector 2	M12 4-pin male D-coded Ethernet - 180° Straight	Ethernet	4	5
M12 Cab D-code Ethernet M0°-RJ45, 5m, Ø5		RJ45 male - n/a	Standard	0.13	No
WI1046-M12M4T10TRJ45	Connector 2	M12 4-pin male D-coded Ethernet - 180° Straight	Ethernet	4	10
M12 Cab D-code Ethernet M0°-RJ45, 10m, Ø5		RJ45 male - n/a	Standard	0.13	No
WI1046-M12M4T15TRJ45	Connector 2	M12 4-pin male D-coded Ethernet - 180° Straight	Ethernet	4	15
M12 Cab D-code Ethernet M0°-RJ45, SFTP, 15m, Ø5		RJ45 male - n/a	Standard	0.13	No
WI1046-M12M4T20TRJ45	Connector 2	M12 4-pin male D-coded Ethernet - 180° Straight	Ethernet	4	20
M12 Cab D-code Ethernet M0°-RJ45, 20m, Ø5		RJ45 male - n/a	Standard	0.13	No
WI1046-M12M4TM4T.3R	Connector 2	M12 4-pin male D-coded Ethernet - 180° Straight	Ethernet	4	0.3
M12 Cab D-code Ethernet M0°-M0°, 0,3m, Ø6		M12 4-pin male D-coded Ethernet - n/a	Robotic - 3D	0.14	No
WI1046-M12M4TM4T.3T	Connector 2	M12 4-pin male D-coded Ethernet - 180° Straight	Ethernet	4	0.3
M12 Cab D-code Ethernet M0°-M0°, 0,3m, Ø6		M12 4-pin male D-coded Ethernet - n/a	Standard	0.13	No
WI1046-M12M4TM4T01R	Connector 2	M12 4-pin male D-coded Ethernet - 180° Straight	Ethernet	4	1
M12 Cab D-code Ethernet M0°-M0°, 1m, Ø7		M12 4-pin male D-coded Ethernet - n/a	Robotic - 3D	0.14	No
WI1046-M12M4TM4T01T	Connector 2	M12 4-pin male D-coded Ethernet - 180° Straight	Ethernet	4	1
M12 Cab D-code Ethernet M0°-M0°, 1m, Ø6		M12 4-pin male D-coded Ethernet - n/a	Standard	0.13	No
WI1046-M12M4TM4T02R	Connector 2	M12 4-pin male D-coded Ethernet - 180° Straight	Ethernet	4	2
M12 Cab D-code Ethernet M0°-M0°, 2,0m, Ø7		M12 4-pin male D-coded Ethernet - n/a	Robotic - 3D	0.14	No
WI1046-M12M4TM4T02T	Connector 2	M12 4-pin male D-coded Ethernet - 180° Straight	Ethernet	4	2
M12 Cab D-code Ethernet M0°-M0°, 2,0m, Ø6		M12 4-pin male D-coded Ethernet - n/a	Standard	0.13	No
WI1046-M12M4TM4T05R	Connector 2	M12 4-pin male D-coded Ethernet - 180° Straight	Ethernet	4	5
M12 Cab D-code Ethernet M0°-M0°, 5m, Ø7		M12 4-pin male D-coded Ethernet - n/a	Robotic - 3D	0.14	No
WI1046-M12M4TM4T05T	Connector 2	M12 4-pin male D-coded Ethernet - 180° Straight	Ethernet	4	5
M12 Cab D-code Ethernet M0°-M0°, 5m, Ø6		M12 4-pin male D-coded Ethernet - n/a	Standard	0.13	No
WI1046-M12M4TM4T10R	Connector 2	M12 4-pin male D-coded Ethernet - 180° Straight	Ethernet	4	10
M12 Cab D-code Ethernet M0°-M0°, 10m, Ø7		M12 4-pin male D-coded Ethernet - n/a	Robotic - 3D	0.14	No
WI1046-M12M4TM4T10T	Connector 2	M12 4-pin male D-coded Ethernet - 180° Straight	Ethernet	4	10
M12 Cab D-code Ethernet M0°-M0°, 10m, Ø6		M12 4-pin male D-coded Ethernet - n/a	Standard	0.13	No
WI1046-M12M4TM4T15R	Connector 2	M12 4-pin male D-coded Ethernet - 180° Straight	Ethernet	4	15
M12 Cab D-code Ethernet M0°-M0°, 15m, Ø7		M12 4-pin male D-coded Ethernet - n/a	Robotic - 3D	0.14	No



MIS171S16ELH266

Int.Step 12-72VDC, Powerlink, EncC-L

Cable information

Item number	Mount on	Cable con 1 +Con 1 angle	Cable application	Wires no totally	Cable length [m]
Item description		Cable con 2 +Con 2 angle	Cable flexibility	Wire [mm2]	Connector 1 LED
WI1046-M12M4TM4T20R	Connector 2	M12 4-pin male D-coded Ethernet - 180° Straight	Ethernet	4	20
M12 Cab D-code Ethernet M0°-M0°, 20m, Ø7		M12 4-pin male D-coded Ethernet - n/a	Robotic - 3D	0.14	No
WI1046-M12M4TM4T20T	Connector 2	M12 4-pin male D-coded Ethernet - 180° Straight	Ethernet	4	20
M12 Cab D-code Ethernet M0°-M0°, 20m, Ø6		M12 4-pin male D-coded Ethernet - n/a	Standard	0.13	No
WI1046-M12M4V02TRJ45	Connector 2	M12 4-pin male D-coded Ethernet - 90° Angled	Ethernet	4	2
M12 Cab D-code Ethernet M90°-RJ45, 2m, Ø5		RJ45 male - n/a	Standard	0.13	No
WI1046-M12M4V05TRJ45	Connector 2	M12 4-pin male D-coded Ethernet - 90° Angled	Ethernet	4	5
M12 Cab D-code Ethernet M90°-RJ45, 5m, Ø6		RJ45 male - n/a	Standard	0.13	No
WI1046-M12M4VM4T.6N	Connector 2	M12 4-pin male D-coded Ethernet - 90° Angled	Ethernet	4	0.6
M12 Cab D-code Ethernet M90°-M0°, 0,6m, Ø6		M12 4-pin male D-coded Ethernet - n/a	Standard	0.13	No
WI1046-M12M4VM4V.6N	Connector 2	M12 4-pin male D-coded Ethernet - 90° Angled	Ethernet	4	0.6
M12 Cab D-code Ethernet M90°-M90°, 0,6m, Ø6		M12 4-pin male D-coded Ethernet - n/a	Standard	0.13	No
WI1048-M12M4TTR1	Connector 2	M12 4-pin male D-coded Ethernet - 180° Straight	Ethernet		Connector
M12 Con 4 p Male D Code Ethernet PressLock		- n/a	n/a		No
WI1046-M12M4S.3NRJ45	Connector 3	M12 4-pin male D-coded Ethernet - 180° Straight	Ethernet	4	0.3
M12 Cab D-code Ethernet M0°-RJ45, 0,3m, Ø5		RJ45 male - n/a	Standard	0.13	No
WI1046-M12M4S01NRJ45	Connector 3	M12 4-pin male D-coded Ethernet - 180° Straight	Ethernet	4	1
M12 Cab D-code Ethernet M0°-RJ45, 1,0m, Ø5		RJ45 male - n/a	Standard	0.13	No
WI1046-M12M4S05NRJ45	Connector 3	M12 4-pin male D-coded Ethernet - 180° Straight	Ethernet	4	5
M12 Cab D-code Ethernet M0°-RJ45, SFTP, 5m, Ø5		RJ45 male - n/a	Standard	0.13	No
WI1046-M12M4S05R	Connector 3	M12 4-pin male D-coded Ethernet - 180° Straight	Ethernet	4	5
M12 Cab D-code Ethernet M0°, SFTP, 5m Ø7		Open Ended - n/a	Cable chains - 2D	0.13	No
WI1046-M12M4S10NRJ45	Connector 3	M12 4-pin male D-coded Ethernet - 180° Straight	Ethernet	4	10
M12 Cab D-code Ethernet M0°-RJ45, 10m, Ø5		RJ45 male - n/a	Standard	0.13	No
WI1046-M12M4S15NRJ45	Connector 3	M12 4-pin male D-coded Ethernet - 180° Straight	Ethernet	4	15
M12 Cab D-code Ethernet M0°-RJ45, 15m, RJ45 Ø5		RJ45 male - n/a	Standard	0.13	No
WI1046-M12M4S15R	Connector 3	M12 4-pin male D-coded Ethernet - 180° Straight	Ethernet	4	15
M12 Cab D-code Ethernet M0°, 15m Ø7		Open Ended - n/a	Cable chains - 2D	0.13	No
WI1046-M12M4T.3TRJ45	Connector 3	M12 4-pin male D-coded Ethernet - 180° Straight	Ethernet	4	0.3
M12 Cab D-code Ethernet M0°-RJ45, 0,3m, RJ45 Ø5		RJ45 male - n/a	Standard	0.13	No
WI1046-M12M4T01TRJ45	Connector 3	M12 4-pin male D-coded Ethernet - 180° Straight	Ethernet	4	1
M12 Cab D-code Ethernet M0°-RJ45, 1m, RJ45 Ø5		RJ45 male - n/a	Standard	0.13	No
WI1046-M12M4T02NRJ45	Connector 3	M12 4-pin male D-coded Ethernet - 180° Straight	Ethernet	4	2
M12 Cab D-code Ethernet M0°-RJ45, 2m, Ø5		RJ45 male - n/a	Standard	0.13	No
WI1046-M12M4T05TRJ45	Connector 3	M12 4-pin male D-coded Ethernet - 180° Straight	Ethernet	4	5
M12 Cab D-code Ethernet M0°-RJ45, 5m, Ø5		RJ45 male - n/a	Standard	0.13	No
WI1046-M12M4T10TRJ45	Connector 3	M12 4-pin male D-coded Ethernet - 180° Straight	Ethernet	4	10
M12 Cab D-code Ethernet M0°-RJ45, 10m, Ø5		RJ45 male - n/a	Standard	0.13	No
WI1046-M12M4T15TRJ45	Connector 3	M12 4-pin male D-coded Ethernet - 180° Straight	Ethernet	4	15
M12 Cab D-code Ethernet M0°-RJ45, SFTP, 15m, Ø5		RJ45 male - n/a	Standard	0.13	No
WI1046-M12M4T20TRJ45	Connector 3	M12 4-pin male D-coded Ethernet - 180° Straight	Ethernet	4	20
M12 Cab D-code Ethernet M0°-RJ45, 20m, Ø5		RJ45 male - n/a	Standard	0.13	No
WI1046-M12M4TM4T.3R	Connector 3	M12 4-pin male D-coded Ethernet - 180° Straight	Ethernet	4	0.3
M12 Cab D-code Ethernet M0°-M0°, 0,3m, Ø6		M12 4-pin male D-coded Ethernet - n/a	Robotic - 3D	0.14	No
WI1046-M12M4TM4T.3T	Connector 3	M12 4-pin male D-coded Ethernet - 180° Straight	Ethernet	4	0.3
M12 Cab D-code Ethernet M0°-M0°, 0,3m, Ø6		M12 4-pin male D-coded Ethernet - n/a	Standard	0.13	No
WI1046-M12M4TM4T01R	Connector 3	M12 4-pin male D-coded Ethernet - 180° Straight	Ethernet	4	1
M12 Cab D-code Ethernet M0°-M0°, 1m, Ø7		M12 4-pin male D-coded Ethernet - n/a	Robotic - 3D	0.14	No
WI1046-M12M4TM4T01T	Connector 3	M12 4-pin male D-coded Ethernet - 180° Straight	Ethernet	4	1
M12 Cab D-code Ethernet M0°-M0°, 1m, Ø6		M12 4-pin male D-coded Ethernet - n/a	Standard	0.13	No



MIS171S16ELH266

Int.Step 12-72VDC, Powerlink, Enc-C-L

Cable information

Item number	Mount on	Cable con 1 +Con 1 angle	Cable application	Wires no totally	Cable length [m]
Item description		Cable con 2 +Con 2 angle	Cable flexibility	Wire [mm2]	Connector 1 LED
WI1046-M12M4TM4T02R	Connector 3	M12 4-pin male D-coded Ethernet - 180° Straight	Ethernet	4	2
M12 Cab D-code Ethernet M0°-M0°, 2,0m, Ø7		M12 4-pin male D-coded Ethernet - n/a	Robotic - 3D	0.14	No
WI1046-M12M4TM4T02T	Connector 3	M12 4-pin male D-coded Ethernet - 180° Straight	Ethernet	4	2
M12 Cab D-code Ethernet M0°-M0°, 2,0m, Ø6		M12 4-pin male D-coded Ethernet - n/a	Standard	0.13	No
WI1046-M12M4TM4T05R	Connector 3	M12 4-pin male D-coded Ethernet - 180° Straight	Ethernet	4	5
M12 Cab D-code Ethernet M0°-M0°, 5m, Ø7		M12 4-pin male D-coded Ethernet - n/a	Robotic - 3D	0.14	No
WI1046-M12M4TM4T05T	Connector 3	M12 4-pin male D-coded Ethernet - 180° Straight	Ethernet	4	5
M12 Cab D-code Ethernet M0°-M0°, 5m, Ø6		M12 4-pin male D-coded Ethernet - n/a	Standard	0.13	No
WI1046-M12M4TM4T10R	Connector 3	M12 4-pin male D-coded Ethernet - 180° Straight	Ethernet	4	10
M12 Cab D-code Ethernet M0°-M0°, 10m, Ø7		M12 4-pin male D-coded Ethernet - n/a	Robotic - 3D	0.14	No
WI1046-M12M4TM4T10T	Connector 3	M12 4-pin male D-coded Ethernet - 180° Straight	Ethernet	4	10
M12 Cab D-code Ethernet M0°-M0°, 10m, Ø6		M12 4-pin male D-coded Ethernet - n/a	Standard	0.13	No
WI1046-M12M4TM4T15R	Connector 3	M12 4-pin male D-coded Ethernet - 180° Straight	Ethernet	4	15
M12 Cab D-code Ethernet M0°-M0°, 15m, Ø7		M12 4-pin male D-coded Ethernet - n/a	Robotic - 3D	0.14	No
WI1046-M12M4TM4T20R	Connector 3	M12 4-pin male D-coded Ethernet - 180° Straight	Ethernet	4	20
M12 Cab D-code Ethernet M0°-M0°, 20m, Ø7		M12 4-pin male D-coded Ethernet - n/a	Robotic - 3D	0.14	No
WI1046-M12M4TM4T20T	Connector 3	M12 4-pin male D-coded Ethernet - 180° Straight	Ethernet	4	20
M12 Cab D-code Ethernet M0°-M0°, 20m, Ø6		M12 4-pin male D-coded Ethernet - n/a	Standard	0.13	No
WI1046-M12M4V02TRJ45	Connector 3	M12 4-pin male D-coded Ethernet - 90° Angled	Ethernet	4	2
M12 Cab D-code Ethernet M90°-RJ45, 2m, Ø5		RJ45 male - n/a	Standard	0.13	No
WI1046-M12M4V05TRJ45	Connector 3	M12 4-pin male D-coded Ethernet - 90° Angled	Ethernet	4	5
M12 Cab D-code Ethernet M90°-RJ45, 5m, Ø6		RJ45 male - n/a	Standard	0.13	No
WI1046-M12M4VM4T.6N	Connector 3	M12 4-pin male D-coded Ethernet - 90° Angled	Ethernet	4	0.6
M12 Cab D-code Ethernet M90°-M0°, 0,6m, Ø6		M12 4-pin male D-coded Ethernet - n/a	Standard	0.13	No
WI1046-M12M4VM4V.6N	Connector 3	M12 4-pin male D-coded Ethernet - 90° Angled	Ethernet	4	0.6
M12 Cab D-code Ethernet M90°-M90°, 0,6m, Ø6		M12 4-pin male D-coded Ethernet - n/a	Standard	0.13	No
WI1048-M12M4TTR1	Connector 3	M12 4-pin male D-coded Ethernet - 180° Straight	Ethernet		Connector
M12 Con 4 p Male D Code Ethernet PressLock		- n/a	n/a		No
WI1005-M12M17SAA01	Connector 4	M12 17-pin male A-coded - 180° Straight	Communication	n/a	Connector
M12 17-pin male Axis 1 Without wire		n/a - n/a	n/a	n/a	No
WI1005-M12M17SAA01W	Connector 4	M12 17-pin male A-coded - 180° Straight	Communication	n/a	Connector
M12 17-pin male Axis 1, with wire 1,2m		n/a - n/a	n/a	n/a	No
WI1005-M12M17SAA02	Connector 4	M12 17-pin male A-coded - 180° Straight	Communication	n/a	Connector
M12 17-pin male Axis 2 Without wire		n/a - n/a	n/a	n/a	No
WI1005-M12M17SAA03	Connector 4	M12 17-pin male A-coded - 180° Straight	Communication	n/a	Connector
M12 17-pin male Axis 3 Without wire		n/a - n/a	n/a	n/a	No
WI1005-M12M17SAA04	Connector 4	M12 17-pin male A-coded - 180° Straight	Communication	n/a	Connector
M12 17-pin male Axis 4 Without wire		n/a - n/a	n/a	n/a	No
WI1005-M12M17SAA05	Connector 4	M12 17-pin male A-coded - 180° Straight	Communication	n/a	Connector
M12 17-pin male Axis 5 Without wire		n/a - n/a	n/a	n/a	No
WI1005-M12M17SAA06	Connector 4	M12 17-pin male A-coded - 180° Straight	Communication	n/a	Connector
M12 17-pin male Axis 6 Without wire		n/a - n/a	n/a	n/a	No
WI1005-M12M17SAA06W	Connector 4	M12 17-pin male A-coded - 180° Straight	Communication	n/a	Connector
M12 17-pin male Axis 6 with wire 1,2m		n/a - n/a	n/a	n/a	No
WI1005-M12M17SAA07	Connector 4	M12 17-pin male A-coded - 180° Straight	Communication	n/a	Connector
M12 17-pin male Axis 7 Without wire		n/a - n/a	n/a	n/a	No
WI1005-M12M17SAA08	Connector 4	M12 17-pin male A-coded - 180° Straight	Communication	n/a	Connector
M12 17-pin male Axis 8 Without wire		n/a - n/a	n/a	n/a	No
WI1005-M12M17SAA09	Connector 4	M12 17-pin male A-coded - 180° Straight	Communication	n/a	Connector
M12 17-pin male Axis 9 Without wire		n/a - n/a	n/a	n/a	No
WI1005-M12M17SAA10	Connector 4	M12 17-pin male A-coded - 180° Straight	Communication	n/a	Connector
M12 17-pin male Axis 10 Without wire		n/a - n/a	n/a	n/a	No
WI1008-M12M17SR1	Connector 4	M12 17-pin male A-coded - 180° Straight	CANopen/DeviceNet n/a		Connector



MIS171S16ELH266

Int.Step 12-72VDC, Powerlink, EncC-L

Cable information

Item number	Mount on	Cable con 1 +Con 1 angle	Cable application	Wires no totally	Cable length [m]
Item description		Cable con 2 +Con 2 angle	Cable flexibility	Wire [mm2]	Connector 1 LED
M12 Con 17p Male 0° Metal housing 5.4-8.2mm cable		- n/a	n/a	n/a	No
WI1009-M12M17T01N	Connector 4	M12 17-pin male A-coded - 180° Straight	Basic I/O, Com	17	1
M12 Shl Cable 1m 17p Mal 0° MISxx,Ex41 twisted		Open Ended - n/a	Standard	0.061	No
WI1009-M12M17T05N	Connector 4	M12 17-pin male A-coded - 180° Straight	Basic I/O, Com	17	5
M12 Shl Cable 5m 17p Mal 0° MISxx,Ex41 twisted		Open Ended - n/a	Standard	0.061	No
WI1009-M12M17T10R	Connector 4	M12 17-pin male A-coded - 180° Straight	Basic I/O, Com	17	5
M12 Shl Cable 10m 17p Mal 0° MISxx,Ex41 twisted		Open Ended - n/a	Robotic - 3D	0.061	No
WI1009-M12M17T20N	Connector 4	M12 17-pin male A-coded - 180° Straight	Basic I/O, Com	17	20
M12 Shl Cable 20m 17p Mal 0° MISxx,Ex41 twisted		Open Ended - n/a	Standard	0.061	No
WI1009-M12M17TF17T.5	Connector 4	M12 17-pin male A-coded - 180° Straight	Basic I/O, Com	17	0.5
M12 Shl Cable.5m Male17p0°-Female 17p0° twist pair		M12 17-pin female A-coded - n/a	Standard	0.061	No
WI1009-M12M17TF17T01	Connector 4	M12 17-pin male A-coded - 180° Straight	Basic I/O, Com	17	1
M12 Shl Cable 1m Male17p0°-Female 17p0° twist pair		M12 17-pin female A-coded - n/a	Standard	0.061	No
WI1009-M12M17TF17T02	Connector 4	M12 17-pin male A-coded - 180° Straight	Basic I/O, Com	17	2
M12 Shl Cable 2m Male17p0°-Female 17p0° twist pair		M12 17-pin female A-coded - n/a	Standard	0.061	No
WI1009-M12M17TF17T03	Connector 4	M12 17-pin male A-coded - 180° Straight	Basic I/O, Com	17	3
M12 Shl Cable 3m Male17p0°-Female 17p0° twist pair		M12 17-pin female A-coded - n/a	Standard	0.061	No
WI1009-M12M17TF17T04	Connector 4	M12 17-pin male A-coded - 180° Straight	Basic I/O, Com	17	4
M12 Shl Cable 4m Male17p0°-Female 17p0° twist pair		M12 17-pin female A-coded - n/a	Standard	0.061	No
WI1009-M12M17V05N	Connector 4	M12 17-pin male A-coded - 90° Angled	Basic I/O, Com	17	5
M12 Shl Cable 5m 17p Mal 90° MISxx,Ex41 twisted		Open Ended - n/a	Standard	0.061	No
WI1009-M12M17V05R	Connector 4	M12 17-pin male A-coded - 90° Angled	Basic I/O, Com		5
M12 Shl Cable 5m 17p Mal 90° MISxx,Ex41 twisted		- n/a	Robotic - 3D		No
WI1009-M12M17V10N	Connector 4	M12 17-pin male A-coded - 90° Angled	Basic I/O, Com	17	10
M12 Shl Cable 10m 17p Mal 90° MISxx,Ex41 twisted		Open Ended - n/a	Standard	0.061	No
RS485-M12-1-5-17	Connector 4 RS485	-			
RS485 M12-17pin DSub, 5m v1.1		-			

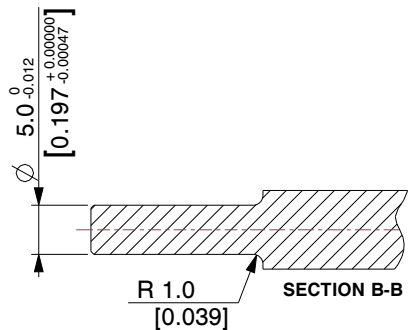

SHAFT DETAILS
SCALE 1.3

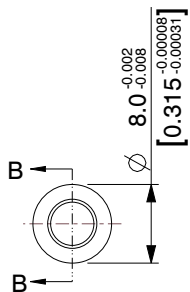

NOTES:

1. Operation Modes : Passive, Position, Gear, Velocity.
2. Encoder Type: Internal, magnetic, absolute 1 rev. Closed loop ready.
Resolution per rev.: 4096 counts / 1024 lines (quadrature output).

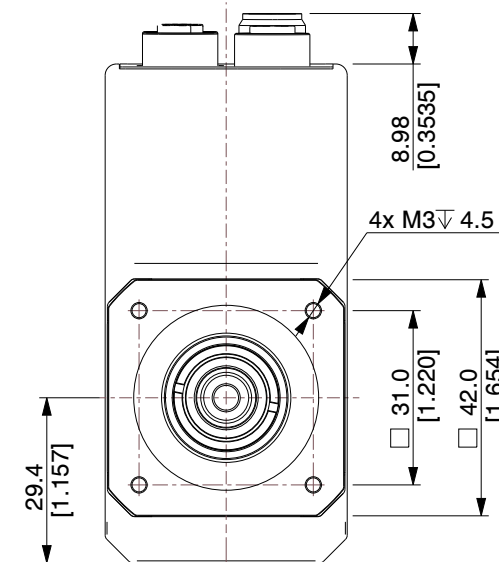
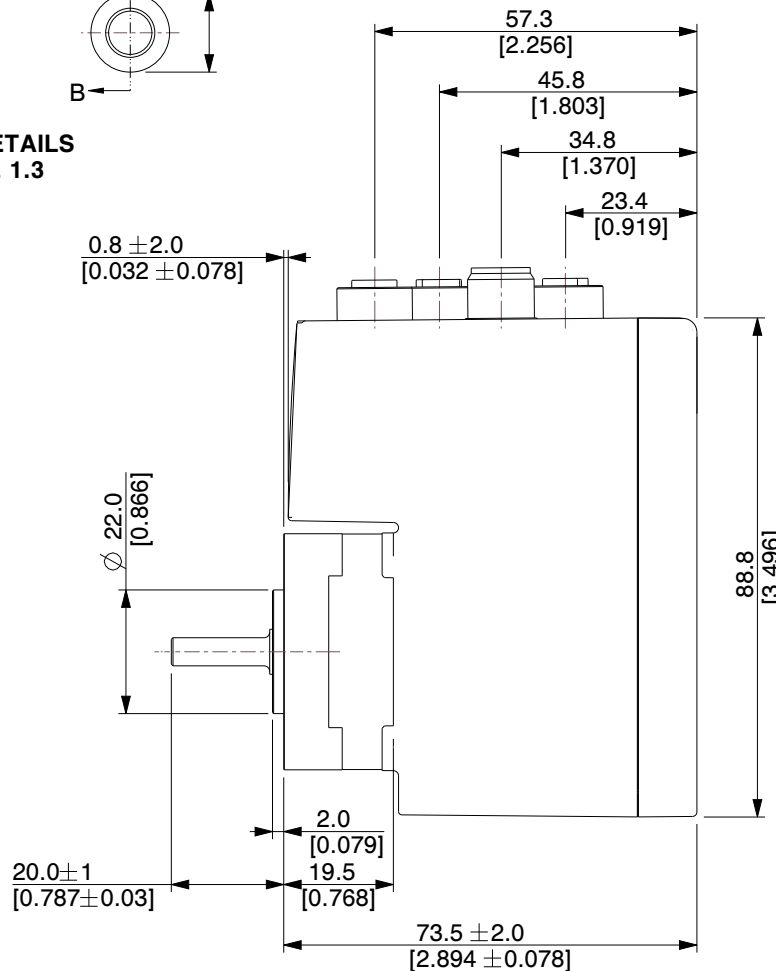
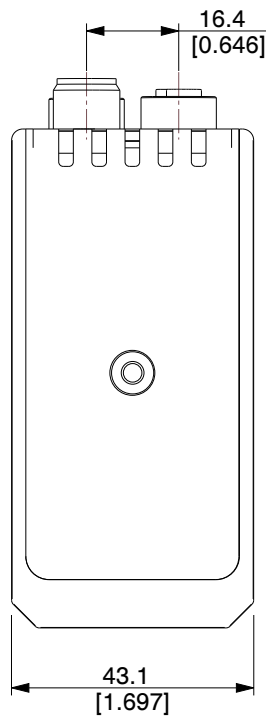
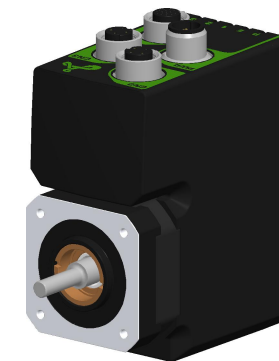

MOTOR SPECIFICATIONS

Running Torque	0.18 Nm	Main Supply Volt.(P+) (nominal)	+ 7-72VDC	Accel./Deceleration (range) / (resolution)	1 - 500000 RPM/s / 1 RPM/s	Communication Interface	Powerlink
Power(watt) @72VDC	48	Control Voltage (CVI)	+ 7-30VDC.	Electronic Gearing (range/resolution)	1/409600 up to 409600/1	Operating Temperature	Ambient 0 to + 40°C (32-104°F)
Velocity (range)	-3000.00 to +3000.00 RPM	Resolution	409600 cnt/rev	Inertia	0.020 kgcm ²	Supply Voltage	SMC66 Controller 6A 12-72VDC
Velocity (resolution)	0.01 RPM	Weight	0.54 kg	Max. axial shaft force	-	Protection	Shaft: IP42, Motor: IP42
Velocity (precision)	± 50 ppm	Connector Type	Radial Connector	Max. radial shaft force	-	Analogue Input (Number/Resolution)	8 inputs available / 12 Bit. (0 to + 5.00 VDC).

JVL A/S
Bregnerødvej 127
DK-3460 Birkerød
Denmark

PART NUMBER:
MIS171S16ELH266

PART DESCRIPTION:
Integrated Stepper Motor

		A4	SCALE	NTS
			UNIT	MM [Inch]

Unless specifically stated otherwise, this drawing is the property of JVL A/S and no feature embodied herein may be disclosed except as previously authorized